



RE-GENERATION

PER UNO SVILUPPO SOSTENIBILE
FOR A SUSTAINABLE DEVELOPMENT

**PLASTICA
ECO-SOSTENIBILE**

**BIO-ATTRIBUTED
PLASTIC**

**RIDOTTE*
EMISSIONI CO₂**
REDUCED EMISSIONS*

* rispetto a un articolo in plastica vergine

**BUSTE IN
CARTA RICICLATA**

**RECYCLED
PAPER PACKAGING**

**RICICLATA
RECYCLED**

made in Italy



Dalla ricerca Arda è nata la prima serie da disegno a **RIDOTTO IMPATTO AMBIENTALE** per aiutare il nostro pianeta :

- PLASTICA "**ECO-SOSTENIBILE**"
- BUSTA IN **CARTA RICICLATA**

Cos'è la plastica "**ECO-SOSTENIBILE**"?

E' una plastica nella quale una parte della componente fossile (petrolio) è sostituita da componente eco-sostenibile, e cioè derivante dal riciclo di rifiuti domestici e residui della lavorazione del legno.

Vantaggi della plastica "**ECO-SOSTENIBILE**"

- **RICICLABILE AL 100%**
- permette il riutilizzo di rifiuti domestici
- riduce l'utilizzo di materiale di origine fossile (petrolio).
- riduce l'emissione gas serra fino al 74%
- preserva le risorse dell'agricoltura poiché non implica lo sfruttamento intensivo dei terreni.

Thanks to ARDA's commitment to environmental issues and deep research, the first drawing line with **REDUCED ENVIRONMENTAL IMPACT** was created to reduce harm to the planet :

- **ECO-SUSTAINABLE** plastic
- **RECYCLED PAPER** bag

What is **ECO-SUSTAINABLE PLASTIC**?

That is a type of plastic in which a part of the fossil component (oil) is replaced by an eco-sustainable component deriving from the recycling of household waste and woodworking residues.

Benefits of eco **SUSTAINABLE PLASTIC**

- **100% RECYCLABLE**
- Allows reuse of household waste
- Reduces the use of the fossil component (oil)
- Reduces greenhouse gas emissions by up to 74%
- Preserves agricultural resources because it doesn't involve extensive land exploitation.



L'équipe de recherche d'ARDA a donné naissance à la première gamme de traçage à **IMPACT ENVIRONNEMENTAL RÉDUIT** pour sauvegarder notre planète.

- Plastique **ÉCO-RESPONSABLE**
- Emballage en **PAPIER RECYCLÉ**

QU'EST-CE QUE DU PLASTIQUE **ÉCO-RESPONSABLE** ?

C'est une matière plastique dans laquelle une partie des composés fossiles (issus du pétrole) est substitué par des composés durables issus du recyclage des déchets ménagers et des résidus de la transformation du bois.

LES AVANTAGES DU PLASTIQUE **ÉCO-RESPONSABLE**

- **RECYCLABLE À 100%**
- Permet la valorisation des déchets domestiques
- Réduit l'utilisation des matériaux fossiles
- Réduction émission de gaz à effet de serre jusqu'à 74%
- Préserve les ressources agricoles puisqu'il n'implique pas l'exploitation intensive des terres cultivables.



Espositori
Display - Presentoirs



Contenuto specifico per disegno tecnico su fogli A3

Specific content for technical drawing on A3 sheets
Contenu spécifique pour le dessin technique sur papier A3



Contenuto specifico per disegno tecnico su fogli A4

Specific content for technical drawing on A4 sheets
Contenu spécifique pour le dessin technique sur papier A4



Ref. RE4768

51
pcs

32 x 25 x 60 h. cm



Ref. 4768F

51
pcs

32 x 25 x 60 h. cm

DISPLAY 51 pz / pcs

Art.	EAN13 art.	Descrizione / Description	INNER	MASTER
RE4768	8003438028167	10x Sq. 45°cm.30 - ref.RE4530 10x Sq. 60°cm.30 - ref. RE6030 10x Righe cm. 30 - ref. RE30 10x Righe cm. 50 - ref. RE50 10x Gon. 360°cm.12 - ref.RE36012 1x bar.24 righelli cm.16 - ref.RE15BAR	1	1

DISPLAY 51 pz / pcs

Art.	EAN13 art.	Descrizione / Description	INNER	MASTER
RE4768F	8003438028464	10x Sq. 45°cm.20 - ref.RE4520 10x Sq. 60°cm.20 - ref. RE6020 20x Righe cm. 30 - ref. RE30 10x Geo300 cm.16 - ref. REGEO300 1x bar.24 righelli cm.16 - ref.RE15BAR	1	1



**RESPECT
PLANET**

Espositore da terra 200 pz.

Floor display stand 200 pcs
Presentoir au sol 200 pcs

200
pcs

Ref. 500RE

39 x 37,5 x 180 h. cm

40x

45° cm.30

Squadra / Set square / Equerre

ref. RE4530

ean 8003438 028020



40x

60° cm.30

Squadra / Set square / Equerre

ref. RE6030

ean 8003438 028037



40x

cm.30

Riga / Ruler / Règle

ref. RE30

ean 8003438 028044



40x

cm.50

Riga / Ruler / Règle

ref. RE50

ean 8003438 028051



40x

360° cm.12

Goniometro / Protractor / Rapporteur

ref. RE36012

ean 8003438 028068



Art.	EAN13 art.	Descrizione / Description	INNER	MASTER
500RE	8003438 028471	Espositore 200 pz - Display 200 pcs	1	1



Squadre 45°
Set square 45°
Equerre 45°

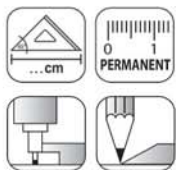

Smusso, tirachina e bordo interno
Bevelled edge, ink-edge and finger lift
Facette, bord anti-tache et bord intérieur

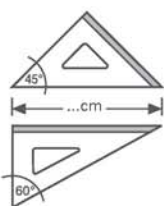

Art.	EAN13 art.	Descrizione / Description	INNER pcs	EAN13 inner	MASTER pcs
RE4520	8003438028426	45° cm. 20	10	8003438028440	
RE4530	8003438028020	45° cm. 30	10	8003438028099	

Squadre 60°
Set square 60°
Equerre 60°

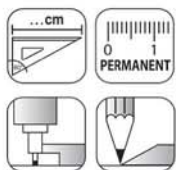

Smusso, tirachina e bordo interno
Bevelled edge, ink-edge and finger lift
Facette, bord anti-tache et bord intérieur

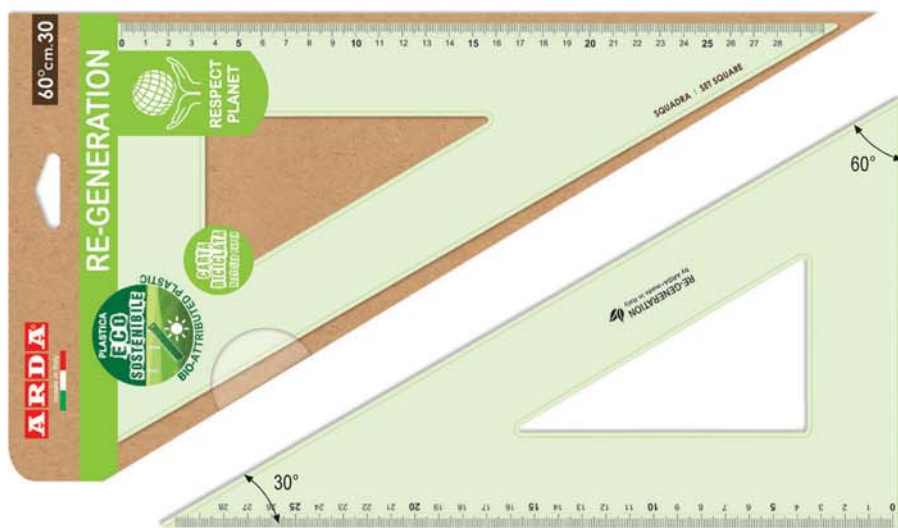

Art.	EAN13 art.	Descrizione / Description	INNER pcs	EAN13 inner	MASTER pcs
RE6020	8003438028433	60° cm. 20	10	8003438028457	
RE6030	8003438028037	60° cm. 30	10	8003438028105	

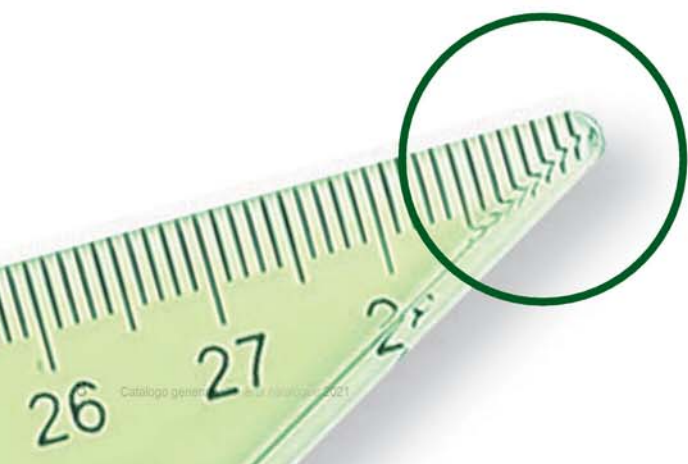

PUNTE ARROTONDATE DI SICUREZZA
ROUND EDGES FOR SECURITY
BOUTS ROUNDS POUR PLUS DE SECURITÉ



Righe
Rulers
Règles

Art.	EAN13 art.	Descrizione	INNER pcs	EAN13 inner
RE30	8003438028044	cm. 30	10	8003438028112
RE50	8003438028051	cm. 50	10	8003438028129



Goniometro 360°
Protractor 360°
Rapporteur 360°

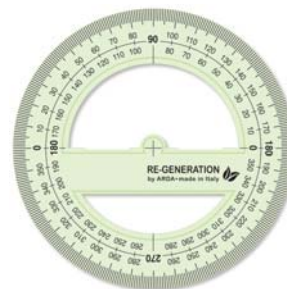
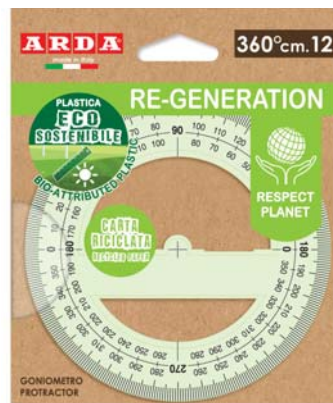

Art.	EAN13 art.	Descrizione	INNER pcs	EAN13 inner
RE36012	8003438028068	360°cm.12	10	8003438028136

Barattolo 24 righelli
Pot 24 rulers
Pot de 24 règles
cm.16



24
pcs



Art.	EAN13 art.	Descrizione	INNER pcs	EAN13 inner
RE15BAR	8003438028327	cm. 16	1	8003438028327

Squadra geometrica
Geometric square
Equerre géométrique
45° cm.16

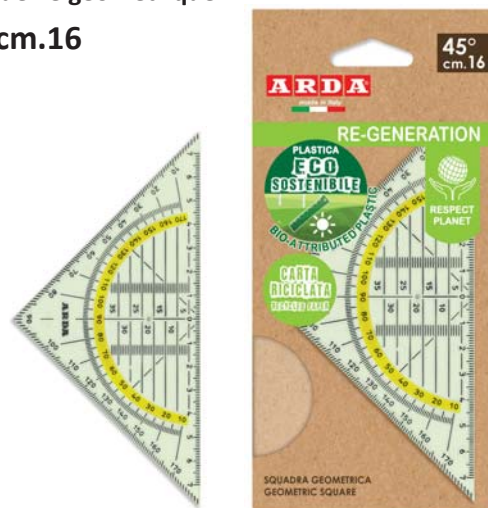

Art.	EAN13 art.	Descrizione	INNER pcs	EAN13 inner
REGE0300	8003438028075	45°cm.16	10	8003438028143

elastika®



L'unica che torna in forma

ARDA®

Made in Italy





elastika®



Made in Italy
Italian quality & design

L'unica che torna in forma

Infinite flexibility

Utility model IT273903 FR1153762.

Dalla ricerca Arda è nata Elastika®, innovativa linea per il disegno.

L'unica che puoi piegare ma torna sempre in forma, senza spezzarsi nè rovinarsi e con la garanzia di utilizzare un vero e proprio strumento da disegno tecnico, che abbina la flessibilità alle altre caratteristiche essenziali: trasparenza, stabilità di forma e precisione delle misure. **Queste le vere differenze che rendono Elastika® unica e inimitabile.**

Elastika®. The only one retaining its original shape

Arda's research has led to the development of Elastika®, an innovative range of technical drawing equipment made using a material offering a major advantage: the ability to bend and revert to its original shape without suffering any damage. It guarantees genuine technical drawing tools, combining flexibility with other essential features: transparency, undeformability and precision measurement.

The real difference that make Elastika® unique and inimitable.

Elastika®. La seule qui conserve ses formes

Le département de recherche d'ARDA a donné naissance à Elastika®, une gamme innovante d'instruments de dessin technique réalisée dans une matière qui permet un résultat extraordinaire: la capacité de se plier et de revenir à sa forme originale sans se déformer est la certitude d'avoir en main un instrument qui allie la souplesse aux autres caractéristiques essentielles : transparence, stabilité de la forme et précision de la mesure.

La vraie différence qui fait de Elastika® une gamme unique et inimitable.

Squadre 45°

Set square 45°
Equerre 45°

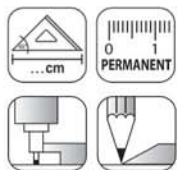

Smusso, tirachina e bordo interno
Bevelled edge, ink-edge and finger lift
Facette, bord anti-tache et bord intérieur



Ref. EL4520 - 30 - 35

Art.	EAN13 art.	Descrizione / Description	INNER pcs	EAN13 inner	MASTER pcs
EL4520	8003438012562	45° cm. 20	10	8003438012579	300
EL4530	8003438011091	45° cm. 30	10	8003438012036	220
EL4535	8003438011114	45° cm. 35	10	8003438012050	140

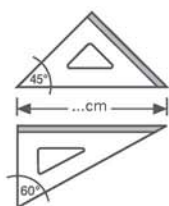

Squadre 60°

Set square 60°
Equerre 60°

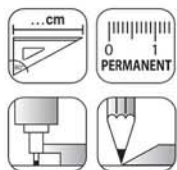

Smusso, tirachina e bordo interno
Bevelled edge, ink-edge and finger lift
Facette, bord anti-tache et bord intérieur



Ref. EL6020 - 30 - 35

Art.	EAN13 art.	Descrizione / Description	INNER pcs	EAN13 inner	MASTER pcs
EL6020	8003438012593	60° cm. 20	10	8003438012609	320
EL6030	8003438011107	60° cm. 30	10	8003438012043	200
EL6035	8003438011121	60° cm. 35	10	8003438012067	100



**PUNTE ARROTONDATE DI SICUREZZA
ROUND EDGES FOR SECURITY
BOUTS ROUNDS POUR PLUS DE SECURITÉ**



* Indistruttibili nelle normali condizioni di utilizzo.
 * Indestructible for a normal use of the instruments.
 * Indestructible dans les conditions normales d'utilisation.

Sicurezza e Qualità

La straordinaria flessibilità, le punte arrotondate e gli angoli smussati rendono questi strumenti assolutamente sicuri. Elastika conferma e migliora la tradizionale qualità Arda: materiali di prima scelta trasparenti e flessibili, millimetri e numeri incisi indelebilmente nella plastica e cifre in grassetto cadenziate per facilitare la lettura.

Safety and Quality

Its extraordinary pliability and rounded corners indeed make all the items in this range absolutely safe. Elastika confirms and improves Arda's traditional reputation for quality: first class materials, completely transparent and incredibly flexible, millimetre markings and numbers indelibly etched in the plastic, with bold highlighting of numbers every 5 cm to facilitate reading.

Securité et Qualité

La sécurité est notre principale préoccupation. La flexibilité, les pointes et les angles arrondis font d'Elastika des instruments à la sécurité maximale. Elastika confirme la tradition de qualité d'ARDA : matériaux de premier choix, transparence absolue et flexibilité incroyable. La graduation gravée est indélébile et les nombres en gras simplifient la lecture.

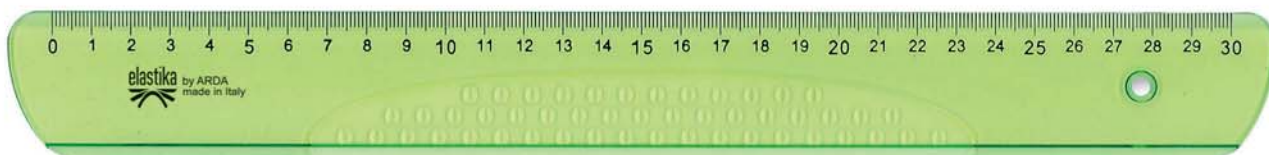

Ref. EL30-50-60



Righe Rulers Règles

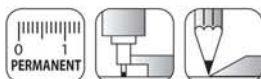

Smusso e tirachina
 Bevelled edge and ink-edge
 Facette et bord anti-tache

Art.	EAN13 art.	Descrizione / Description	INNER pcs	EAN13 inner	MASTER pcs
EL30	8003438011138	cm. 30	10	8003438012074	300
EL50	8003438011152	cm. 50	10	8003438012081	200
EL60	8003438013453	cm. 60	10	8003438013460	150



Righelli 15 cm

Rulers 15 cm
Règle 15 cm

20
pz/pcs

Ref. EL15ESP



Smusso
Bevelled edge
Facette



Smusso "intelligente" per sollevare facilmente il righello dal foglio

"smart" bevel to easily lift the ruler from the sheet

Biseau "intelligent" pour prise en main facile de la règle



Ref. EL15

Art.	EAN13 art.	Descrizione / Description	INNER pcs	EAN13 inner	MASTER pcs
EL15ESP	8003438017963	Display 20 righelli cm.15 (art. sing. 8003438 018014)	1	8003438017963	1
EL15	8003438018014	Righello Elastika cm.15	10	8003438018021	10

Doppi e Tripli decimetri

Finger grip ruler 20-30cm
Double e triple décimètre

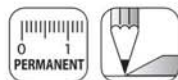

2 millimetrature. Impugnatura corta
2 graduations. Short grip
2 graduations. Poignée courte



Ref. EL20P

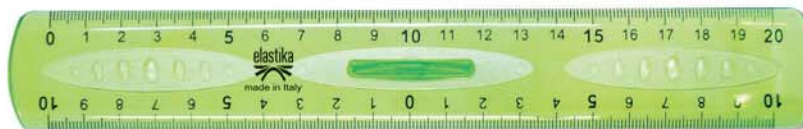

Ref. EL30P



Art.	EAN13 art.	Descrizione / Description	INNER pcs	EAN13 inner	MASTER pcs
EL20P	8003438011176	cm. 20	10	8003438012098	200
EL30P	8003438011213	cm.30	10	8003438012104	240

Goniometro 180°

Protractor 180°
Rapporteur 180°

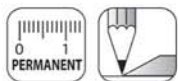

Smusso e bordo interno
Bevelled edge and finger lift
Facette et bord intérieur

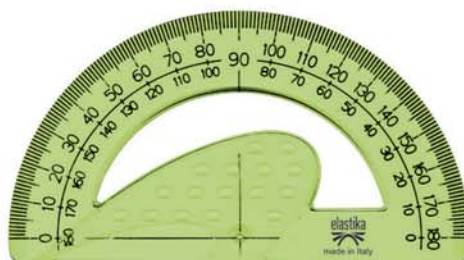

Ref. EL18012



Art.	EAN13 art.	Descrizione / Description	INNER pcs	EAN13 inner	MASTER pcs
EL18012	8003438011404	180° cm. 12	10	8003438012111	200

Goniometro 360°

Protractor 360°
Rapporteur 360°

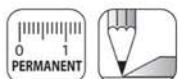

Smusso e bordo interno
Bevelled edge and finger lift
Facette et bord intérieur

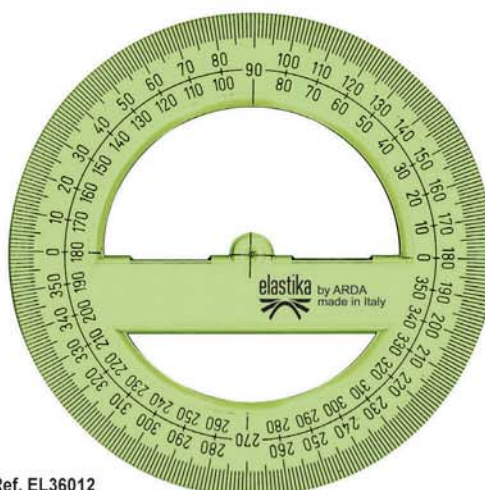

Ref. EL36012



Art.	EAN13 art.	Descrizione / Description	INNER pcs	EAN13 inner	MASTER pcs
EL36012	8003438011411	360° cm. 12	10	8003438012128	360

Squadra geometrica

Geometric square
Equerre géométrique

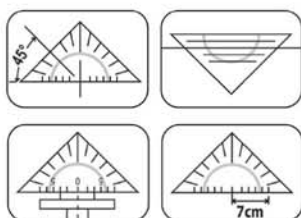

Ref. ELGEO300

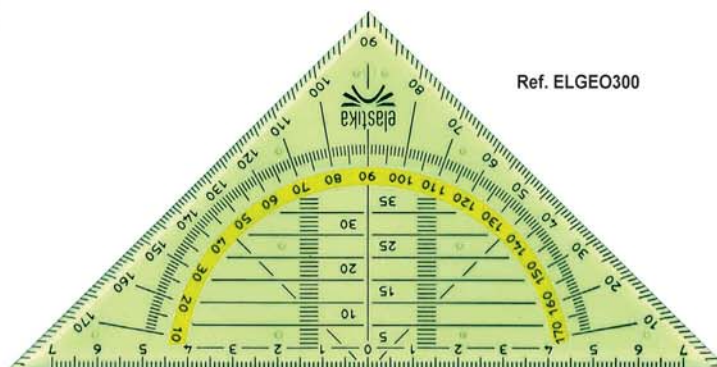

4 funzioni in 1
4 fonctions in 1 - 4 usages en 1

Art.	EAN13 art.	Descrizione / Description	INNER pcs	EAN13 inner	MASTER pcs
ELGEO300	8003438016140	Geo300 - 45° cm. 16	20	8003438016157	400

Espositori

Display - Presentoirs



Contenuto specifico per disegno tecnico su fogli A3

Specific content for technical drawing on A3 sheets
Contenu spécifique pour le dessin technique sur papier A3



Contenuto specifico per disegno tecnico su fogli A4

Specific content for technical drawing on A4 sheets
Contenu spécifique pour le dessin technique sur papier A4



Ref. EL4766
35,5 x 24 x 63 h. cm

61
pcs



Ref. EL4765F
35,5 x 24 x 63 h. cm

90
pcs

DISPLAY 61 pz / pcs

Art.	EAN13 art.	Descrizione / Description	INNER	MASTER
EL4766	8003438017987	10x Sq. 45°cm.30 - ref.EL4530 10x Sq. 60°cm.30 - ref. EL6030 1x display 20 righelli cm. 15 - ref.EL15ESP 10x Righe cm. 50 - ref. EL50 10x Doppio dec. - ref. EL20P 10x Triplo dec. - ref. EL30P 10x Gon. 360°cm.12 - ref.EL36012	1	1

Disponibilità limitata alle campagne promozionali - Product availability limited to promotional campaigns - Disponibilité limitée aux campagnes promotionnelles

DISPLAY 90 pz / pcs

Art.	EAN13 art.	Descrizione / Description	INNER	MASTER
EL4765F	8003438013781	10x Sq. 45°cm.20 - ref. EL4520 20x Sq. 60°cm.20 - ref. EL6020 10x Righe cm.30 - ref. EL30 20x Doppio dec. - ref. EL20P 10x Triplo dec. - ref. EL30P 20x Gon. 180°cm.12 - ref.EL18012	1	1

Disponibilità limitata alle campagne promozionali - Product availability limited to promotional campaigns - Disponibilité limitée aux campagnes promotionnelles

**MANCINI
LEFT**

**PER DISEGNO
TECNICO E SCOLASTICO
FOR TECHNICAL AND SCHOOL USE
POUR EMPLOI TECHNIQUE ET
SCOLAIRE.**

Made in Italy
Italian quality & design

**Millimetratura speciale per mancini :
invertita da destra verso sinistra**

**Special graduation for left-handers
from right to left.**

**Graduation spéciale pour gauchers
de droit à gauche.**





Squadre

Set square
Equerre

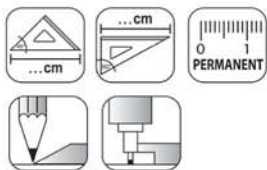

Smusso, tirachina e bordo interno
Bevelled edge, ink-edge and finger lift
Facette, bord anti-tache et bord intérieur

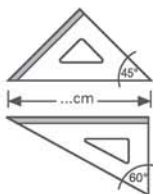

**PUNTE
ARROTONDATE DI
SICUREZZA**

**ROUND EDGES FOR
SECURITY**

**BOUTS ROUNDS POUR
PLUS DE SECURITÉ**

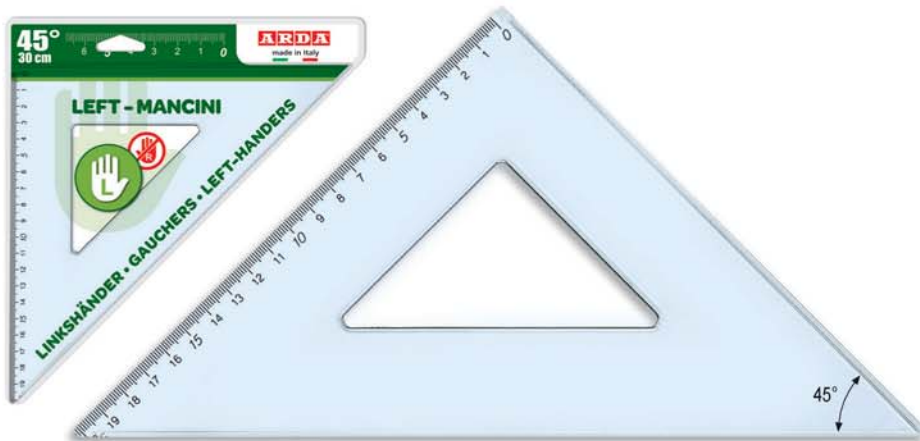

Ref. 28720MAN - 28730MAN



Ref. 28820MAN - 28830MAN

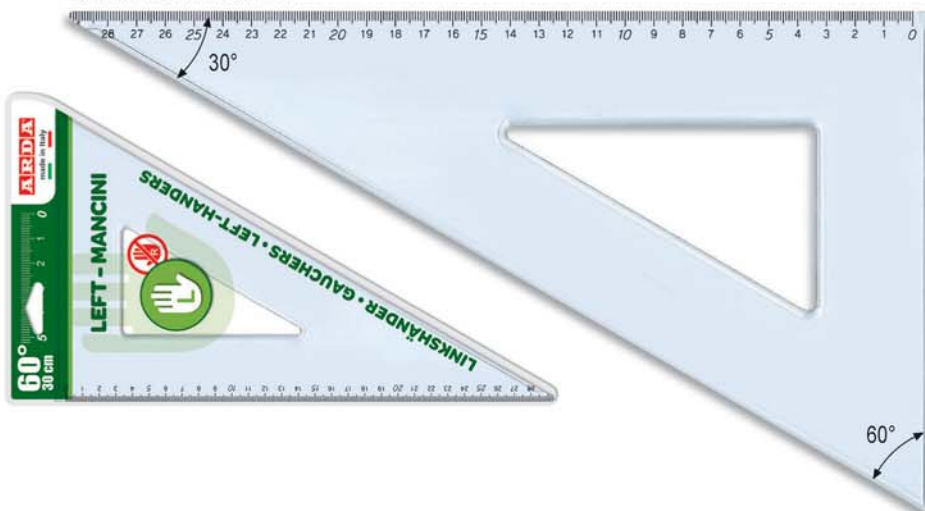

Art.	EAN13 art.	Descrizione / Description	INNER pcs	EAN13 inner	MASTER pcs
28720MAN	8003438002495	45° cm. 20	10	8003438007537	10
28820MAN	8003438002518	60° cm. 20	10	8003438007544	10
28730MAN	8003438021618	45° cm. 30	10	8003438021663	10
28830MAN	8003438021625	60° cm. 30	10	8003438021670	10

Righe

Rulers
Règles

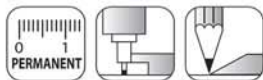

Disponibile in cm. 17 - 30 - 50



Smusso e tirachina
Bevelled edge and ink-edge
Facette et bord anti-tache

Art.	EAN13 art.	Descrizione / Description	INNER pz/pcs	EAN13 inner	MASTER pz/pcs
28917MAN	8003438021649	cm 17	10	8003438021694	10
28930MAN	8003438006899	cm 30	10	8003438007551	10
28950MAN	8003438021595	cm 50	10	8003438021656	10



Doppio decimetro

Finger grip ruler 20 cm
Double décimètre

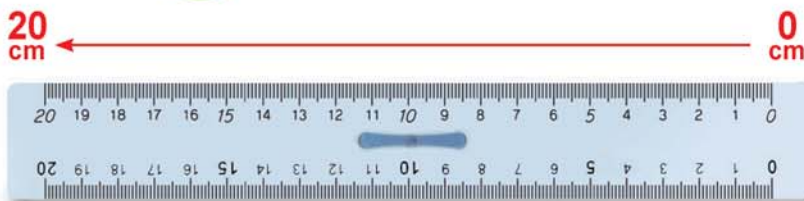
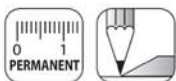

Ref. 283MAN



2 millimetature. Impugnatura corta.
2 graduations. Short grip.
2 graduations. Poignée corte.

Art.	EAN13 art.	Descrizione / Description	INNER pz/pcs	EAN13 inner	MASTER pz/pcs
283MAN	8003438021632	cm. 20	10	8003438021687	10

Barattolo 24 righelli cm.16

Pot containing 24 rulers cm.16
Pot de 24 règles cm.16

La mano del GENIO!



24 pcs

Art.	EAN13 art. 8003438...	INNER pz/pcs	EAN13 inner 8003438...	MASTER pz/pcs
17DMANBAR	...023353	1	...023353	10

colori assortiti - assorted colours - couleurs assorties
Articolo singolo / Each articles / Article à l'unité : 8003438 023346

Ref. 17DMANBAR



Set disegno 3 pz.

Drawing set 3 pcs
Set de traçage 3 pcs

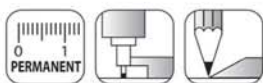

Smusso e tirachina
Bevelled edge and ink-edge
Facette et bord anti-tache



Ref. 70420MAN



Ref. 704303MAN

Art.	EAN13 art.	Descrizione / Description	INNER pz/pcs	EAN13 inner	MASTER pz/pcs
70420MAN	8003438002471	R30 + 45°/20 cm + 60°/20 cm	25	8003438007797	25
704303MAN	8003438022356	R30 + 45°/30 cm + 60°/30 cm	20	8003438022363	20



Espositore Display - Presentoir

DISPLAY 70 pz / pcs

Art.	EAN13 art.	Descrizione / Description	INNER	MASTER
4766MAN	8003438021724	10x Sq. 45° cm.30 - ref.28730MAN 10x Sq. 60° cm.30 - ref.28830MAN 10x Righello cm.17 - ref.28917MAN 10x Righe cm.30 - ref. 28930MAN 10x Righe cm.50 - ref.28950MAN 10x Set 3 pz. - ref.70420MAN 10x Doppio dec. - ref. 283MAN	1	1

Disponibilità limitata alle campagne promozionali - Product availability limited to promotional campaigns - Disponibilité limitée aux campagnes promotionnelles



Contenuto per disegno tecnico su fogli A4 e A3
Content for technical drawing on A4 and A3 sheets
Contenu pour le dessin technique sur papier A4 et A3

Forbici per mancini

Scissors for left-handers
Ciseaux pour gauchers

LEFT | cm. 13

Autentiche forbici per mancini, con lame a molatura speculare. Impugnatura in ABS.

Real left-hand scissors, with specular blades : ABS grip.

Veritables ciseaux pour gaucher, avec lames inversées. Poignée ABS.



Ref. FA1206

Art.	EAN13 art.	Descrizione / Description	INNER pcs	EAN13 inner	MASTER pcs
FA1206	8003438011169	in blister	10	8003438011565	100

Made in Italy

 Italian quality & design

**PER DISEGNO
 TECNICO E SCOLASTICO**

**FOR TECHNICAL AND SCHOOL USE
 POUR EMPLOI TECHNIQUE ET SCOLAIRE.**



In polistirolo di grande trasparenza e durezza superficiale, per garantire resistenza e durata nel tempo. Articoli in colore fumé ottico riposante per gli occhi. Graduazione incisa a caldo con caratteri facilmente leggibili e molto precisi. La maggior parte degli articoli è munita di bordo tira-china sui lati non graduati. Gli articoli sono confezionati in busta appendibile che può essere riutilizzata per proteggere il prodotto da graffi e rotture. Imballo in scatole da 20 pezzi.

Produced using polystyrene with a high level of transparency and surface hardness to guarantee toughness and long-term durability. The articles are in smoky grey, suitable for all types of use. The graduation is heat etched, easy to read and very accurate. Most of the articles are equipped with an inking edge on the non-graduated sides. The articles are packaged in individual pouches with hang tabs which can be re-used to protect the item from scratching and breakage. Packaging in personalised boxes containing 20 pieces.

Elle est réalisée en polystyrène d'une transparence très élevée et dureté superficielle qui garantissent résistance et dureté dans le temps. Les articles sont en couleur gris fumé indiqué pour tous les usages. La graduation est gravée à chaud avec des chiffres très clairement lisibles et précis. La plupart des articles est fournie avec un bord antitache sur les côtés non gradués. Les articles sont conditionnés sous pochette accrochable qu'on peut réutiliser pour protéger le produit de rayures et ruptures. Les boîtes sont de 20 pcs. à la marque propre.

Squadre 45°
Set square 45°
Equerre 45°

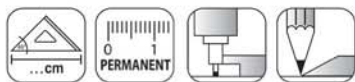

Smusso, tirachina e bordo interno
Bevelled edge, ink-edge and finger lift
Facette, bord anti-tache et bord intérieur

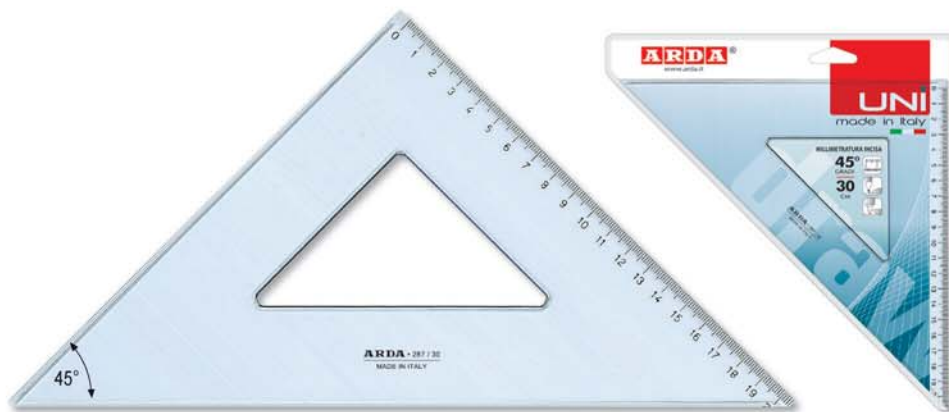

Ref. 28712- 15 - 20 - 25 - 30 - 35 SS

Art.	EAN13 art.	Descrizione / Description	INNER pcs	EAN13 inner	MASTER pcs
28712SS	8003438287120	45° cm. 12	20	8003438487124	500
28715SS	8003438287151	45° cm. 15	20	8003438487155	900
28720SS	8003438287205	45° cm. 20	20	8003438487209	400
28725SS	8003438287250	45° cm. 25	20	8003438487254	300
28730SS	8003438287304	45° cm. 30	20	8003438487308	200
28735SS	8003438287359	45° cm. 35	20	8003438487353	160

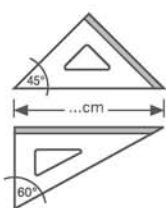

Squadre 60°
Set square 60°
Equerre 60°

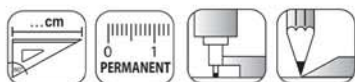

Smusso, tirachina e bordo interno
Bevelled edge, ink-edge and finger lift
Facette, bord anti-tache et bord intérieur

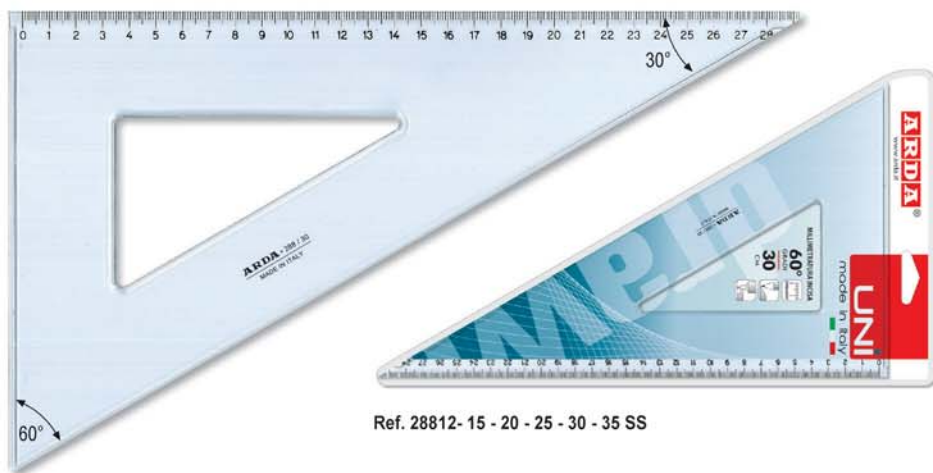

Ref. 28812- 15 - 20 - 25 - 30 - 35 SS

Art.	EAN13 art.	Descrizione / Description	INNER pcs	EAN13 inner	MASTER pcs
28812SS	8003438288127	60° cm. 12	20	8003438488121	500
28815SS	8003438288158	60° cm. 15	20	8003438488152	880
28820SS	8003438288202	60° cm. 20	20	8003438488206	400
28825SS	8003438288257	60° cm. 25	20	8003438488251	260
28830SS	8003438288301	60° cm. 30	20	8003438488305	200
28835SS	8003438288356	60° cm. 35	20	8003438488350	200

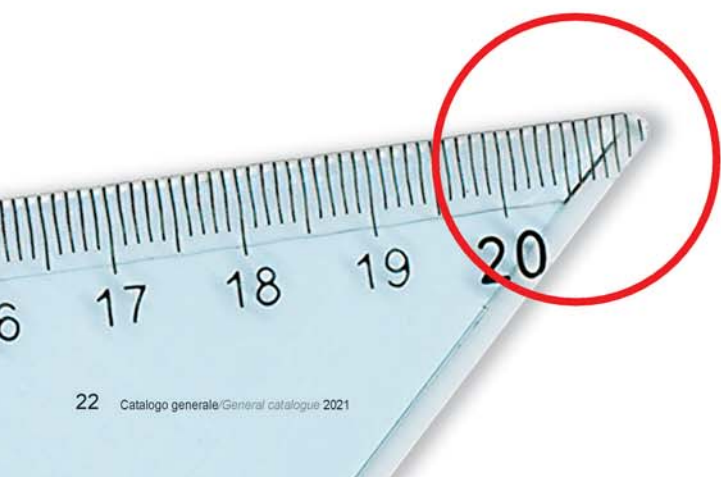

PUNTE ARROTONDATE DI SICUREZZA
ROUND EDGES FOR SECURITY
BOUTS ROUNDS POUR PLUS DE SÉCURITÉ

Righe

Rulers
Règles

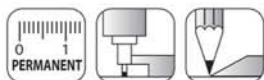

Smusso e tirachina
Bevelled edge and ink-edge
Facette et bord anti-tache



Ref. 28920 - 30 - 40 - 50 - 60 SS ▪ Ref. 28970C - 80C - 100C - 120C

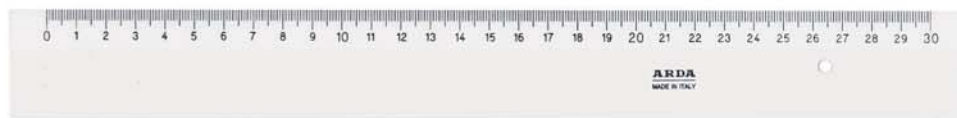

Ref. 50030SS riga bianca/white ruler/règle blanche

Art.	EAN13 art.	Descrizione / Description	INNER pcs	EAN13 inner	MASTER pcs
28920SS	8003438289209	cm. 20	20	8003438489203	700
28930SS	8003438289308	cm. 30	20	8003438489302	400
50030SS	8003438050038	cm. 30 bianco/white/blanc	20	8003438450036	360
28940SS	8003438289407	cm. 40	20	8003438489401	200
28950SS	8003438289506	cm. 50	20	8003438489500	200
28960SS	8003438289605	cm. 60	20	8003438489609	200
* 28970C	8003438289704	cm. 70	10	8003438489708	10
* 28980C	8003438289803	cm. 80	10	8003438489807	10

Cm. 100 e cm. 120 : colore cristallo e materiale flessibile super resistente
Cm.100 and cm.120 : cristal color - strong and flexible material
Cm.100 and cm.120 : couleur cristal - matière durable et flexible

* 289100C	8003438289100	cm. 100 (colore cristallo)	1	8003438289100	10
* 289120C	8003438026125	cm. 120 (colore cristallo)	1	8003438026125	10

* Packaging : busta cellophane

Righe graduazione verticale

Rulers vertical graduation
Règles graduation verticale



Smusso e tirachina
Bevelled edge and ink-edge
Facette et bord anti-tache

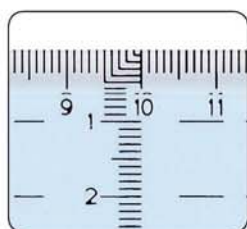

Ref. 28920 - 30 - 40 - 50 GVSS

Art.	EAN13 art.	Descrizione / Description	INNER pcs	EAN13 inner	MASTER pcs
28920GVSS	8003438289216	cm. 20	20	8003438489210	700
28930GVSS	8003438289315	cm. 30	20	8003438489319	400
28940GVSS	8003438289414	cm. 40	20	8003438489418	200
28950GVSS	8003438289513	cm. 50	20	8003438489517	200

Doppi decimetri

Finger grip ruler 20 cm
Double décimètre



impugnatura corta • short grip • poignée courte



Ref. 283SS

impugnatura lunga • long grip • poignée longue



Ref. 286SS

Art.	EAN13 art.	Descrizione / Description	INNER pz/pcs	EAN13 inner	MASTER pz/pcs
283SS	8003438002839	20 cm impugnatura corta/short grip/poignée courte	20	8003438022837	300
286SS	8003438002860	20 cm impugnatura lunga/long grip/poignée longue	20	8003438028600	240

Triplo decimetro

Finger grip ruler 30cm
Triple décimètre

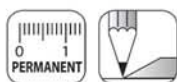

impugnatura lunga • long grip • poignée longue

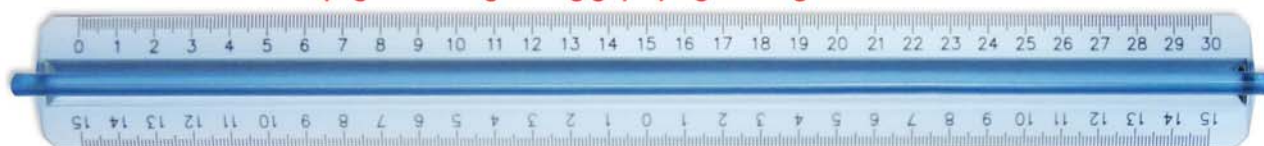

Ref. 50130SS

Art.	EAN13 art.	Descrizione / Description	INNER pz/pcs	EAN13 inner	MASTER pz/pcs
50130SS	8003438005014	30 cm impugnatura lunga/long grip/poignée longue	20	8003438025012	160

Decimetro

Ruler 10cm
Décimètre

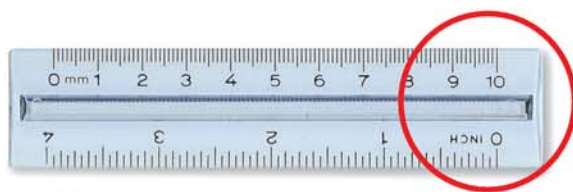
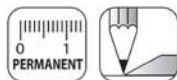

Doppia graduazione
Double graduation
mm / inch

Ref. 280C

Art.	EAN13 art.	Descrizione / Description	INNER pcs	EAN13 inner	MASTER pcs
280C	8003438002808	Decimetro - 10 cm	20	8003438202802	500

Righelli 17cm

Ruler 17cm
Règles 17cm

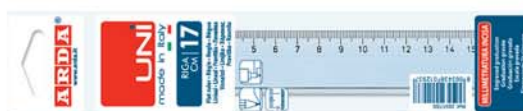
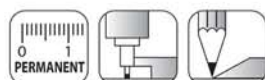

Ref. 28917SS



Ref. 28917

Art.	EAN13 art.	Descrizione / Description	INNER pcs	EAN13 inner	MASTER pcs
28917SS	8003438012937	cm. 17	20	8003438012944	800
28917	8003438289179	cm. 17 sfuso / bulk / vrac	150	8003438228918	150

Righelli quadri

Square rulers
Règles carrée



Ref. 77 15 cm ■ 7x7 mm



Ref. 50230C 30 cm ■ 8x12 mm



Art.	EAN13 art.	Descrizione / Description	INNER pcs	EAN13 inner	MASTER pcs
77	8003438770004	cm. 15 - mm. 7x7	250	8003438077004	250
50230C	8003438502308	cm. 30 - mm. 8x12	20	8003438450234	360

Goniometri 180°

Protractor 180°
Rapporteur 180°



Smusso e bordo interno
Bevelled edge and finger lift
Facette et bord intérieur

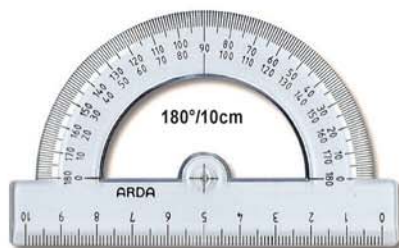

Ref. 294SS
Con decimetro
With ruler 10 cm - Avec décimètre



Ref. 284SS



Ref. 296SS



Art.	EAN13 art.	Descrizione / Description	INNER pcs	EAN13 inner	MASTER pcs
294SS	8003438002945	180° cm.10 con decim.	20	8003438212948	900
284SS	8003438002846	180° cm.12	20	8003438212849	660
296SS	8003438002969	180° cm.15	20	8003438202963	20

Goniometri 360°

Protractor 360°
Rapporteur 360°



Smusso e bordo interno
Bevelled edge and finger lift
Facette et bord intérieur



Ref. 285SS

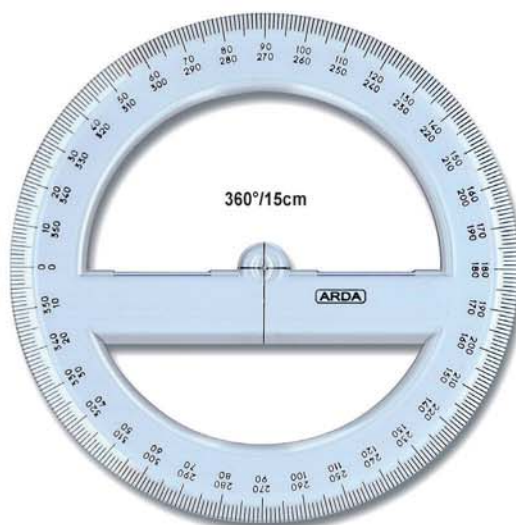

Ref. 297SS



Art.	EAN13 art.	Descrizione / Description	INNER pcs	EAN13 inner	MASTER pcs
285SS	8003438002853	360° cm.12	20	8003438212856	480
297SS	8003438002976	360° cm.15	20	8003438202970	360

Curvilinee

French curves
Set de 3 pistolets

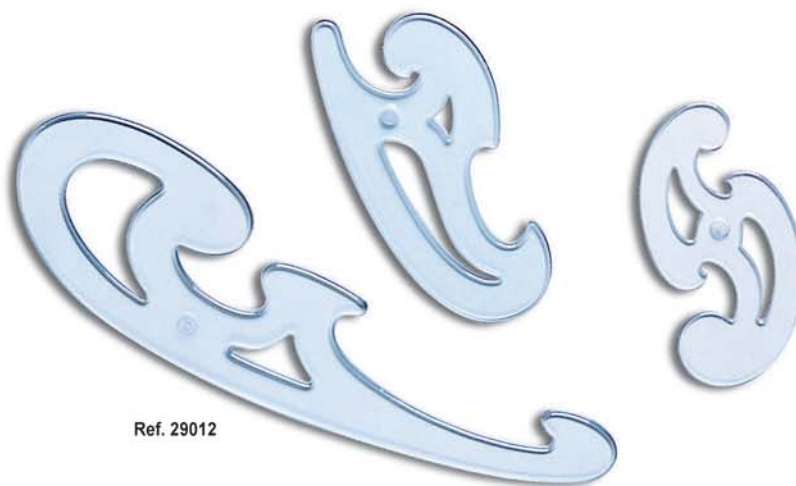

Con doppio tirachina
With double ink-edge
Double bord anti-tache

Ref. 29012

Art.	EAN13 art.	Descrizione / Description	INNER pcs	EAN13 inner	MASTER pcs
29012	8003438290120	Set 3 pz curvilinee/french curves/pistolets	10	8003438229014	190

Espositore

Display
Presentoir



Contenuto specifico per disegno tecnico su fogli A3

Specific content for technical drawing on A3 sheets
Contenu spécifique pour le dessin technique sur papier A3

200 pcs

Ref. 4765

39,5 x 19 x 63 h. cm

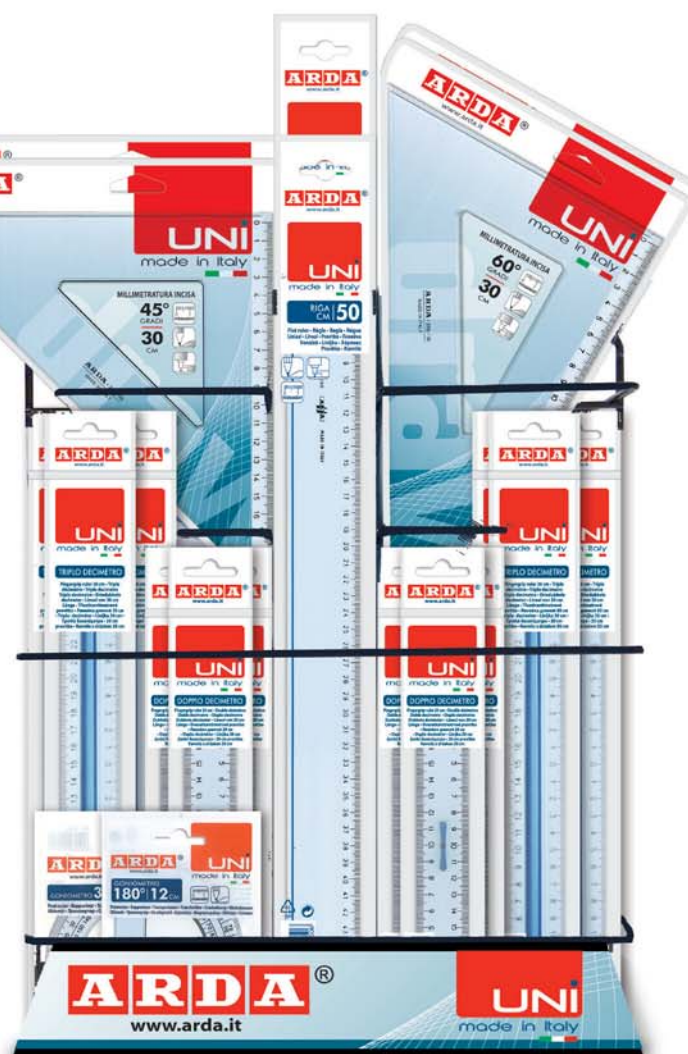

DISPLAY 200 pz / pcs

Art.	EAN13 art.	Descrizione / Description	INNER	MASTER
4765	8003438047656	20x Sq. 45° cm. 30 20x Sq. 60° cm. 30 20x Sq. 45° cm. 35 20x Sq. 60° cm. 35 20x Righe cm. 50 20x Righe cm. 60 20x Doppio dec. cm. 20 20x Triplo dec. cm. 30 20x Gon. 180° cm. 12 20x Gon. 360° cm. 12	1	1

Disponibilità limitata alle campagne promozionali - Product availability limited to promotional campaigns - Disponibilité limitée aux campagnes promotionnelles

Coppia squadre

Set of 2 squares
Couple 2 équerres



Smusso, tirachina e bordo interno
Bevelled edge, ink-edge and finger lift
Facette, bord anti-tache et bord intérieur

- Punta arrotondate di sicurezza
- Round edges for security
- Bouts ronds pour plus de sécurité

Confezione rettangolare per coppia squadre cm. 12 - 15



Confezione triangolare per coppia squadre cm. 30 - 35



Art.	EAN13 art.	Descrizione / Description	INNER pcs	EAN13 inner	MASTER pcs
70312SS	8003438703125	45° + 60° cm. 12	20	8003438723123	260
70315SS	8003438703156	45° + 60° cm. 15	20	8003438723154	260
70330SS	8003438703309	45° + 60° cm. 30	20	8003438723307	120
70335SS	8003438703354	45° + 60° cm. 35	20	8003438723352	120

Set disegno 4 pz

Drawing set 4 pcs
Set de traçage 4 pcs



* eccetto goniometro
except protractor - sauf que rapporteur

Smusso, tirachina e bordo interno
Bevelled edge, ink-edge and finger lift
Facette, bord anti-tache et bord intérieur



Ref. 705



Ref. 70420SS - ref. 70430SS

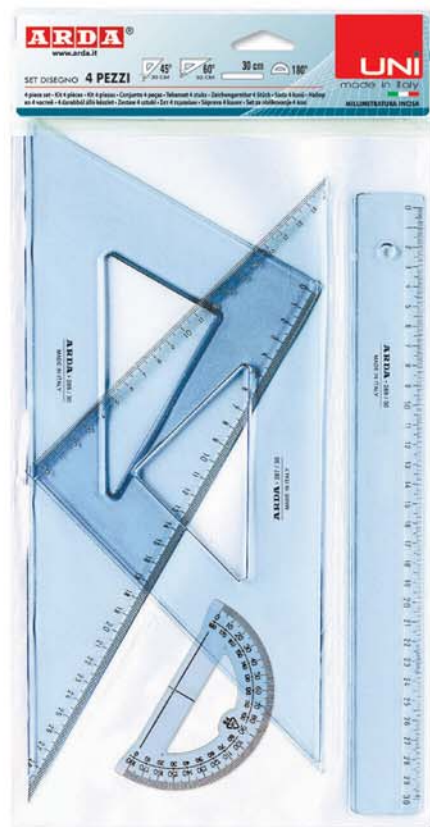

Art.	EAN13 art.	Descrizione / Description	INNER pcs	EAN13 inner	MASTER pcs
705	8003438705006	Miniset: 45°-60° cm.15 - R20 - 180°/10cm	20	8003438725004	20
70420SS	8003438704207	Set 4 pz/pcs: 45°-60° cm.20 - R20 180°/10cm	10	8003438724205	140
70430SS	8003438704306	Set 4 pz/pcs: 45°-60° cm.30 - R30 180°/10cm	20	8003438724304	120

Righe T

T-squares
Règle à "T"

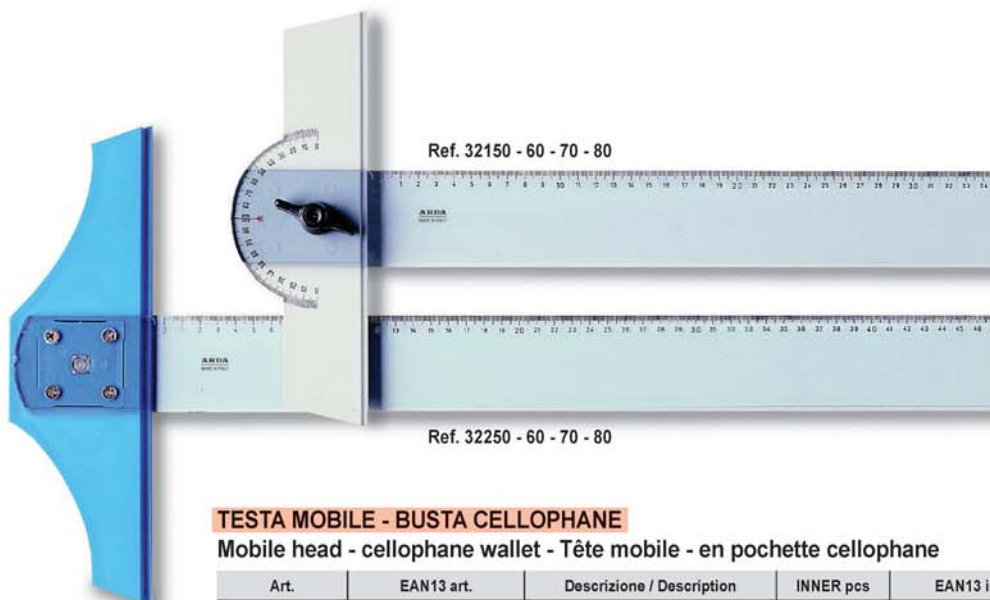

TESTA MOBILE - BUSTA CELLOPHANE

Mobile head - cellophane wallet - Tête mobile - en pochette cellophane

Art.	EAN13 art.	Descrizione / Description	INNER pcs	EAN13 inner	MASTER pcs
32150	8003438321503	cm. 50	10	8003438432155	10
32160	8003438321602	cm. 60	10	8003438432162	10
32170	8003438321701	cm. 70	10	8003438432179	10
32180	8003438321800	cm. 80	10	8003438432186	10

TESTA FISSA - BUSTA CELLOPHANE

Fixed head - cellophane wallet - Tête fixe en pochette cellophane

Art.	EAN13 art.	Descrizione / Description	INNER pcs	EAN13 inner	MASTER pcs
32250	8003438322500	cm. 50	10	8003438432254	10
32260	8003438322609	cm. 60	10	8003438432261	10
32270	8003438322708	cm. 70	10	8003438432278	10
32280	8003438322807	cm. 80	10	8003438432285	10

Righe parallele

Parallel rulers
Règles parallèles



Ref. 325SC



Art.	EAN13 art.	Descrizione / Description	INNER pcs	EAN13 inner	MASTER pcs
325SC	8003438325006	cm.30	1	8003438325006	5

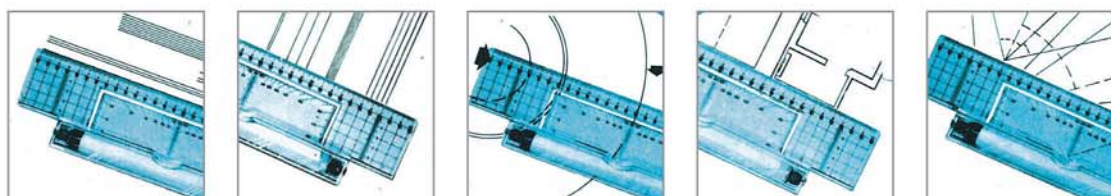

Squadre geometriche

Geometric square
Equerre géométrique



4 funzioni in 1
4 functions in 1
4 usages en 1

16 cm

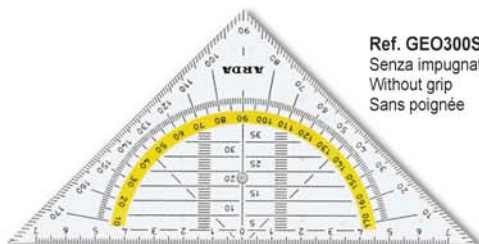

Ref. GEO300SS
Senza impugnatura
Without grip
Sans poignée



Art.	EAN13 art.	Descrizione / Description	INNER pcs	EAN13 inner	MASTER pcs
GEO300SS	8003438003003	45° cm. 16 senza impugn.	20	8003438413000	1000

25 cm



Ref. GEO401PSS con impugnatura removibile
with removable grip - avec poignée amovible

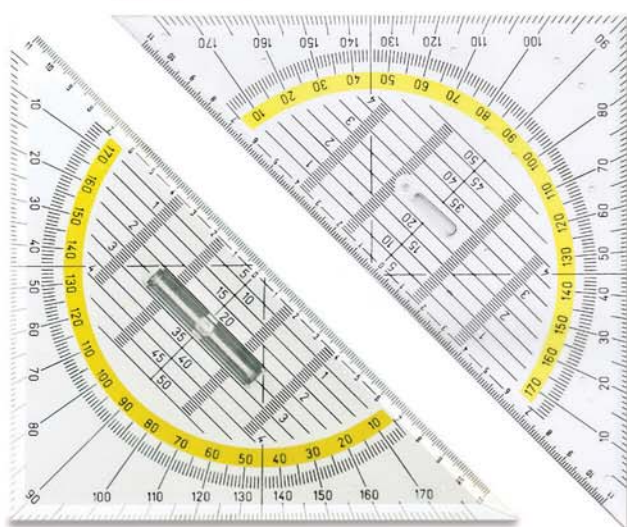

Ref. GEO400PSS
Impugnatura fissa
Fixed grip
Poignée fixée

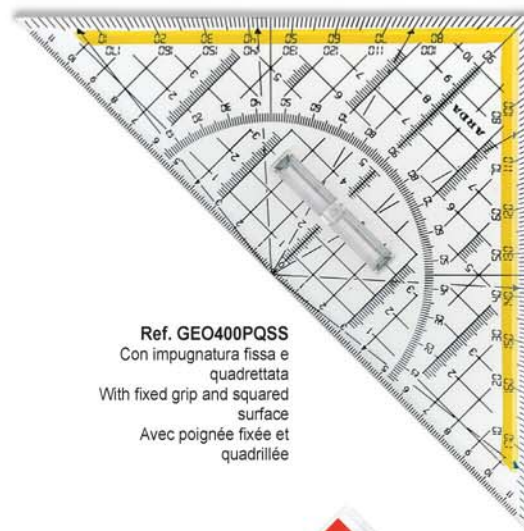

Ref. GEO400PQSS
Con impugnatura fissa e
quadrettata
With fixed grip and squared
surface
Avec poignée fixée et
quadrillée

Art.	EAN13 art.	Descrizione / Description	INNER pcs	EAN13 inner	MASTER pcs
GEO400PSS	8003438014009	45° cm. 25 imp. fissa	10	8003438414007	200
GEO400PQSS	8003438008299	45° cm. 25 imp. fissa + quadr.	10	8003438008305	200
GEO401PSS	8003438024008	45° cm. 25 imp. removibile	20	8003438424006	200



Set 2 squadre geometriche + Riga 30 cm

2 geometric square + ruler 30 cm

2 équerre géométrique + règle 30 cm

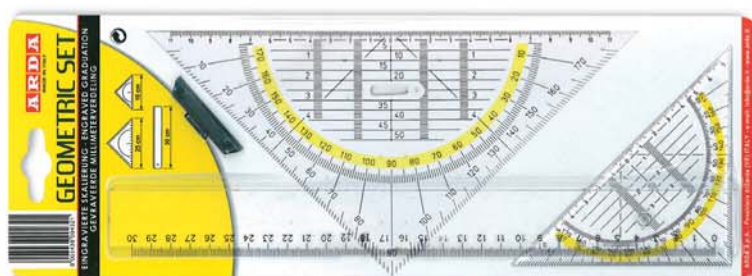

Ref. GEO2/30

GEO 16 cm : senza impugnatura
without grip / sans poignée

GEO 25 cm : con impugnatura removibile
with movable grip / avec poignée amovible

Art.	EAN13 art.	Descrizione / Description	INNER pcs	EAN13 inner	MASTER pcs
GEO2/30	8003438004321	GEO 16 cm + GEO 25 cm + Riga/ruler/règle 30 cm	50	8003438004338	50

Righelli in plastica per l'astuccio



Barattolo righelli 17 cm modello largo

Pot containing rulers - large
Pot de règles - larges

Ean singolo/per item/à l'unité



FLUO
colours

Ref. 28917BAR

30
pcs

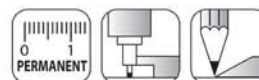

Art.	EAN13 art. 8003438...	INNER pz/pcs	EAN13 inner 8003438...	MASTER pz/pcs
28917BAR	...289186	1	...289186	20

colori assortiti - assorted colours - couleurs assorties

Articolo singolo / Each articles / Article à l'unité : 8003438 016539

Barattolo righelli 15 cm modello stretto

Pot containing rulers - narrow
Pot de règles - étroites



50
pcs

Ref. 282C

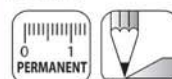

Art.	EAN13 art. 8003438...	INNER pz/pcs	EAN13 inner 8003438...	MASTER pz/pcs
282C	...002822	1	...002822	20

colori assortiti - assorted colours - couleurs assorties

**Barattolo righelli 15 cm
modello stretto**

Pot containing rulers - narrow
Pot de règles - étroites

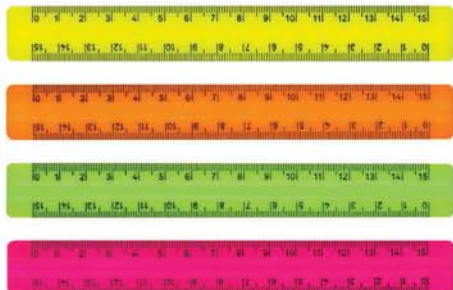

FLUO
colours

50
PCS

Ref. 282FL

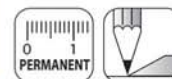

Art.	EAN13 art. 8003438...	INNER pz/pcs	EAN13 inner 8003438...	MASTER pz/pcs
282FL	...026101	1	...026101	20

colori assortiti - assorted colours - couleurs assorties

Barattolo doppi decimetri

Pot containing finger grip rulers 20 cm
Pot de double décimètre

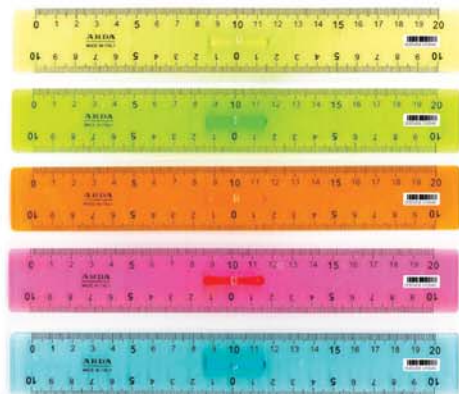

FLUO
colours

10
PCS

Ref. 283BAR



Art.	EAN13 art. 8003438...	INNER pz/pcs	EAN13 inner 8003438...	MASTER pz/pcs
283BAR	...012838	1	...012838	10

colori assortiti - assorted colours - couleurs assorties

Articolo singolo / Each articles / Article à l'unité : 8003438 016546

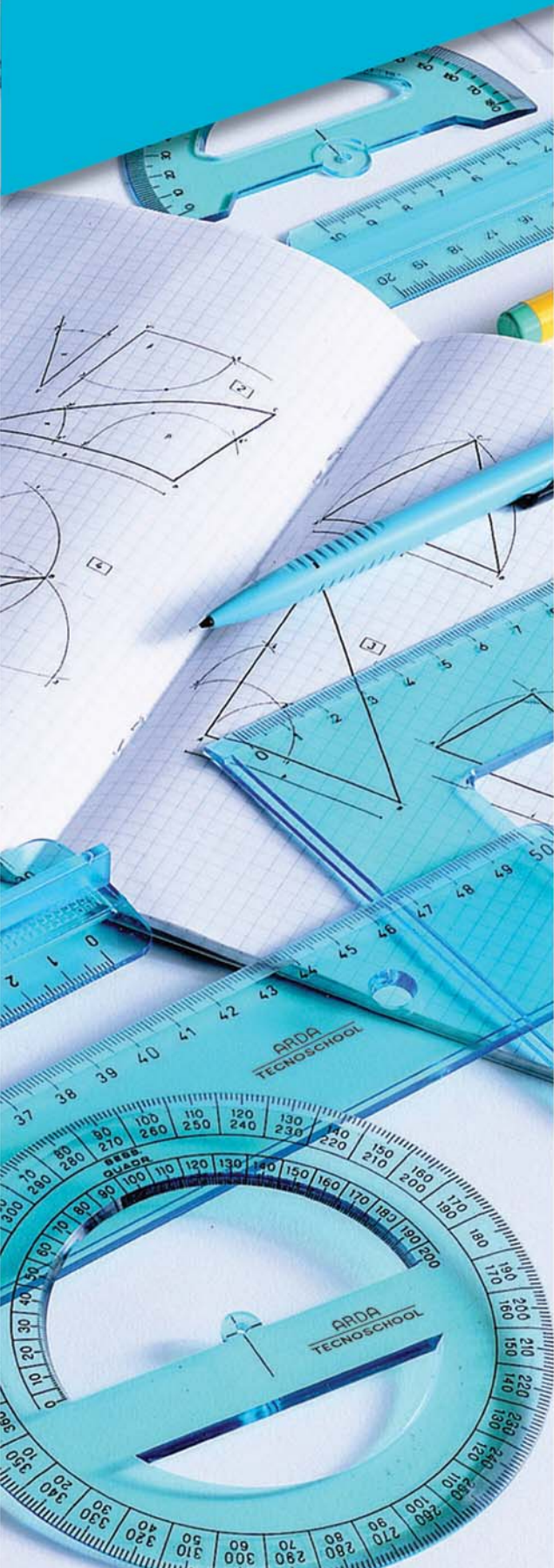

ECCELLENTE RAPPORTO
QUALITÀ / PREZZO.

EXCELLENT VALUE FOR MONEY.

UN RAPPORT EXCELLENT ENTRE
PRIX ET QUALITÉ.

Made in Italy
Italian quality & design

Gli articoli sono in polistirolo di colore azzurro e confezionati in busta PPL appendibile e riutilizzabile. La graduazione è incisa, facilmente leggibile e molto precisa.

The articles are made of polystyrene, blue colour and packaged individually in a reusable PPL wallet with hang tab. Etched easy-to-read graduation with a high level of accuracy.

Les articles sont en polystyrene en couleur bleu et en pochette PPL accrochable et réutilisable. La graduation est gravée à chaud avec un standard de précision et lisibilité très élevé.

Squadre

Set square
Equerre



Smusso, tirachina e bordo interno
Bevelled edge, ink-edge and finger lift
Facette, bord anti-tache et bord intérieur

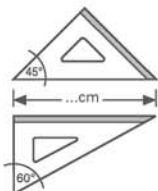

**PUNTE ARROTONDATE
DI SICUREZZA**

**ROUND EDGES FOR
SECURITY**

**BOUTS ROUNDS POUR
PLUS DE SECURITÉ**

Ref. 40115 - 20 - 25 - 30 - 35 SS

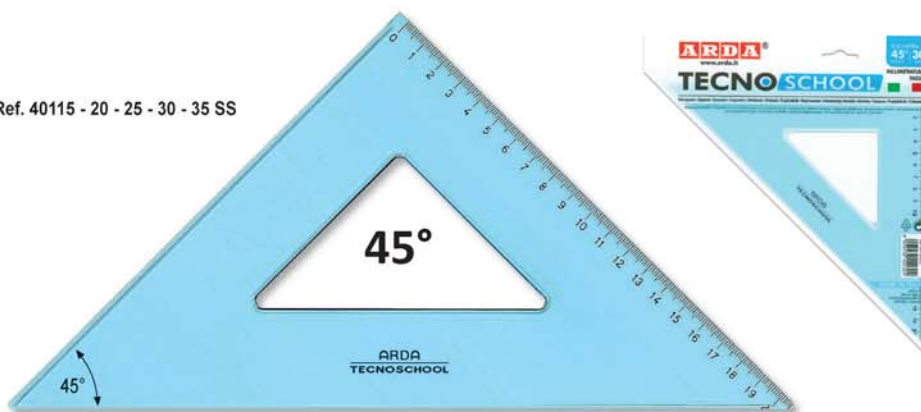

Art.	EAN13 art.	Descrizione / Description	INNER pcs	EAN13 inner	MASTER pcs
40115SS	8003438401151	45° cm. 15	20	8003438421159	900
40120SS	8003438401205	45° cm. 20	20	8003438421203	400
40125SS	8003438401250	45° cm. 25	20	8003438421258	300
40130SS	8003438401304	45° cm. 30	20	8003438421302	200
40135SS	8003438401359	45° cm. 35	20	8003438421357	160

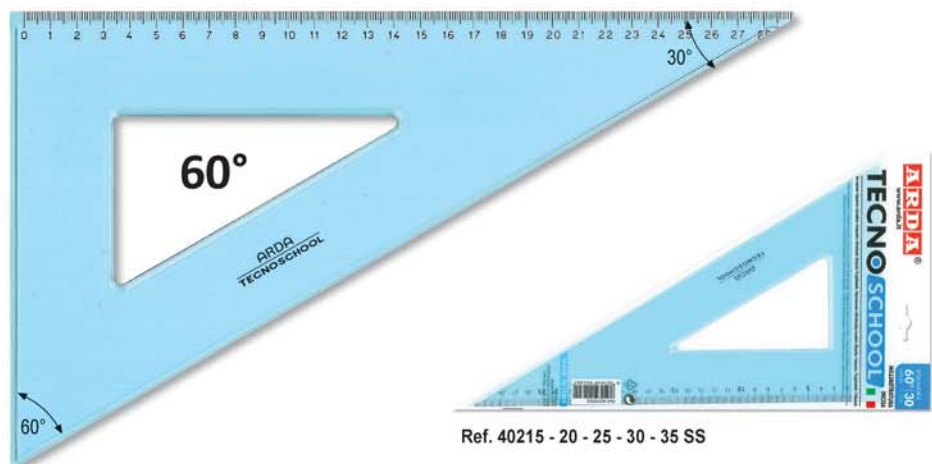

Ref. 40215 - 20 - 25 - 30 - 35 SS

Art.	EAN13 art.	Descrizione / Description	INNER pcs	EAN13 inner	MASTER pcs
40215SS	8003438402158	60° cm. 15	20	8003438422156	880
40220SS	8003438442208	60° cm. 20	20	8003438422200	400
40225SS	8003438402257	60° cm. 25	20	8003438422255	260
40230SS	8003438402301	60° cm. 30	20	8003438422309	200
40235SS	8003438402356	60° cm. 35	20	8003438422354	200

Righe

Rulers
Règles



Smusso e tirachina
Bevelled edge and ink-edge
Facette et bord anti-tache

Ref. 40020 - 30 - 40 - 50 - 60 SS



Art.	EAN13 art.	Descrizione / Description	INNER pcs	EAN13 inner	MASTER pcs
40020SS	8003438400208	cm. 20	20	8003438420206	700
40030SS	8003438400307	cm. 30	20	8003438420305	400
40040SS	8003438400406	cm. 40	20	8003438420404	200
40050SS	8003438400505	cm. 50	20	8003438420503	200
40060SS	8003438400604	cm. 60	20	8003438420602	200

Doppio e Triplo decimetro

Finger grip ruler 20-30cm
Double e triple décimètre

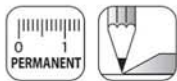

2 millimetrature. Impugnatura corta.
2 graduations. Short grip.
2 graduations. Poignée courte.

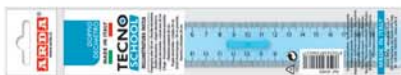

Ref. 403SS



Ref. 406SS

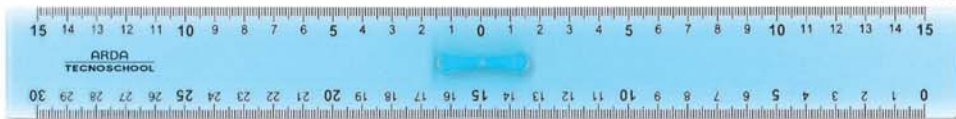

Art.	EAN13 art.	Descrizione / Description	INNER pcs	EAN13 inner	MASTER pcs
403SS	8003438004031	cm. 20	20	8003438104038	300
406SS	8003438004062	cm. 30	20	8003438104069	160

Goniometri

Protractor
Rapporteur

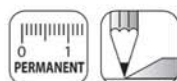

Smusso e bordo interno
Bevelled edge and finger lift
Facette et bord intérieur



Ref. 404SS

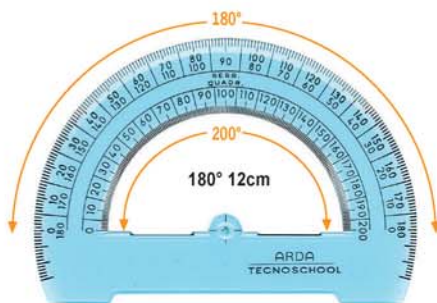

Ref. 407SS

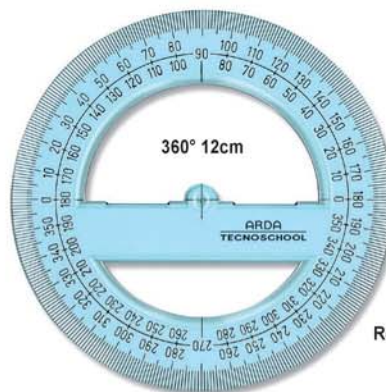

Ref. 405SS



Art.	EAN13 art.	Descrizione / Description	INNER pcs	EAN13 inner	MASTER pcs
404SS	8003438004048	180° cm.10	20	8003438104045	900
407SS	8003438004079	180° cm.12	20	8003438104076	660
405SS	8003438004055	360° cm.12	20	8003438104052	480

Curvilinee

French curves
Set de 3 pistolets



Con doppio tirachina
With double ink-edge
Double bord anti-tache

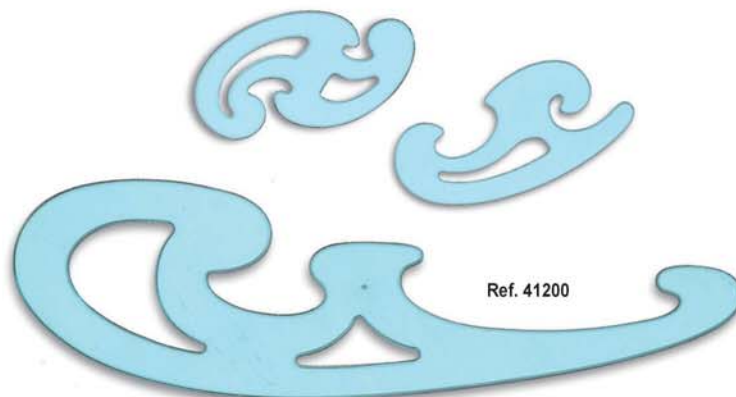

Ref. 41200



Art.	EAN13 art.	Descrizione / Description	INNER pcs	EAN13 inner	MASTER pcs
41200	8003438412003	Set 3 pz curvilinee/french curves/pistolets	10	8003438412027	190

Coppia Squadre

Set of 2 squares
Pochette 2 équerres

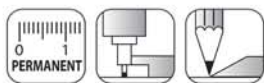

Smusso, tirachina e bordo interno
Bevelled edge, ink-edge and finger lift
Facette, bord anti-tache et bord intérieur

Ref. 60330SS - 60335SS

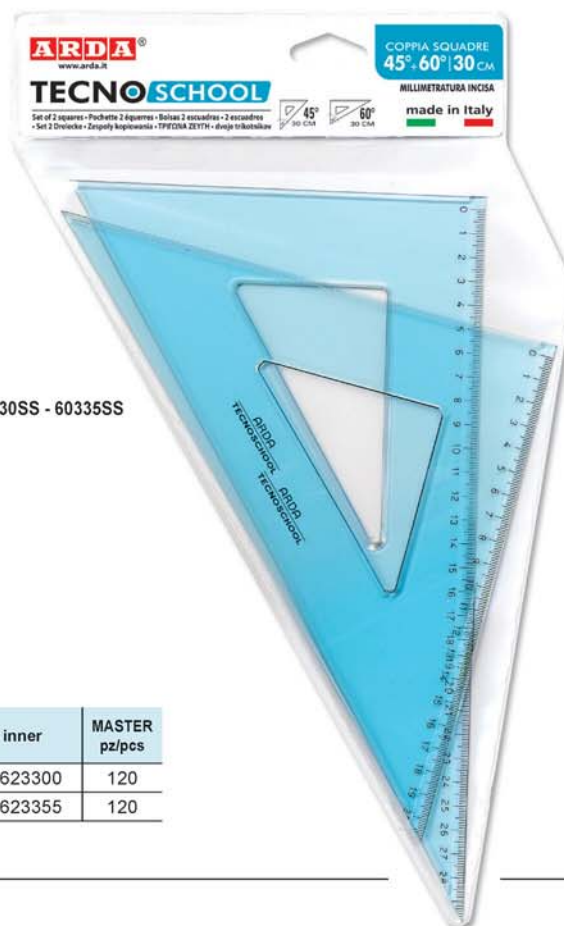

Art.	EAN13 art.	Descrizione / Description	INNER pz/pcs	EAN13 inner	MASTER pz/pcs
60330SS	8003438603302	45° + 60° cm. 30	20	8003438623300	120
60335SS	8003438603357	45° + 60° cm. 35	20	8003438623355	120

Set disegno

Drawing set
Set de traçage

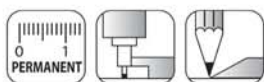

* eccetto goniometro
except protractor
sauf que rapporteur

Smusso, tirachina e bordo interno
Bevelled edge, ink-edge and finger lift
Facette, bord anti-tache et bord intérieur



Ref. 706
MINISET 4 PZ



Ref. 7063
MINISET 3 PZ



Ref. 60430SS
SET 4 PZ

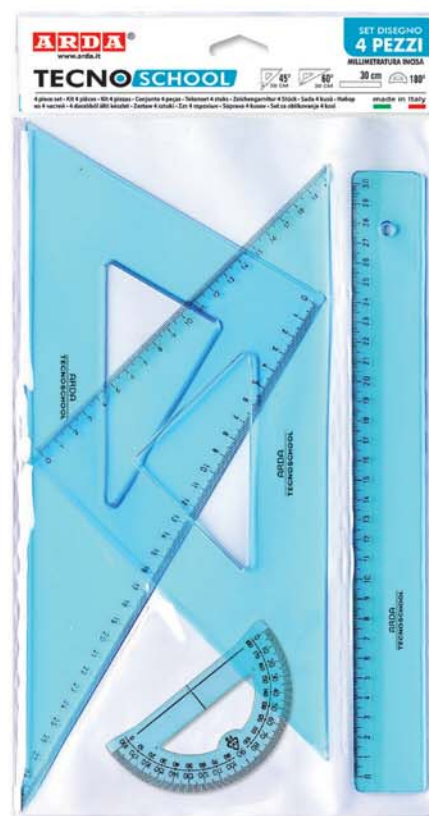

Art.	EAN13 art.	Descrizione / Description	INNER pz/pcs	EAN13 inner	MASTER pz/pcs
706	8003438706003	Miniset 4 pz: 45°-60° cm.15 - R20 - 180°/10cm	20	8003438726001	20
7063	8003438013835	Miniset 3 pz: 45°-60° cm.15 - R17	20	8003438013842	20
60430SS	8003438604309	Set 4 pz/pcs: 45°-60° cm.30 - R30 180°/10cm	20	8003438624307	20

Espositore
Display
Presentoir



Contenuto specifico per disegno tecnico su fogli A3

Specific content for technical drawing on A3 sheets

Contenu spécifique pour le dessin technique sur papier A3

200
pcs

Ref. 6640
39.5 x 19 x 63 h. cm

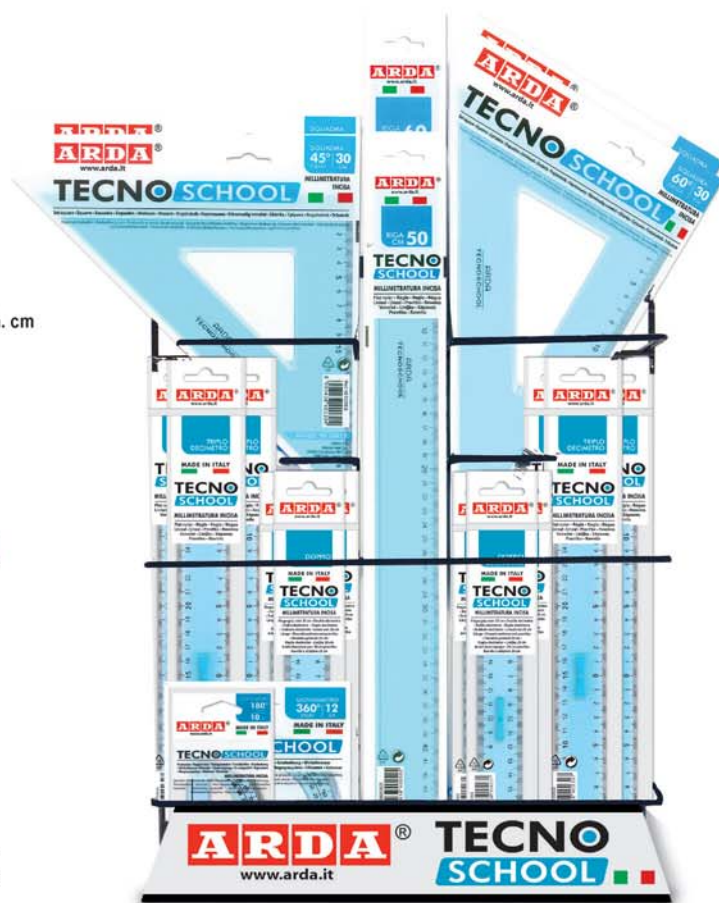

DISPLAY 200 pz / pcs

Art.	EAN13 art.	Descrizione / Description	INNER	MASTER
6640	8003438664006	20x Sq. 45° cm. 30 20x Sq. 60° cm. 30 20x Sq. 45° cm. 35 20x Sq. 60° cm. 35 20x Righe cm. 50 20x Righe cm. 60 20x Doppio dec. cm. 20 20x Triplo dec. cm. 30 20x Gon. 180° cm. 12 20x Gon. 360° cm. 12	1	1

Disponibilità limitata alle campagne promozionali - Product availability limited to promotional campaigns - Disponibilité limitée aux campagnes promotionnelles

TECNO SCHOOL

FLUO
colours



Ref. 40016FLAS

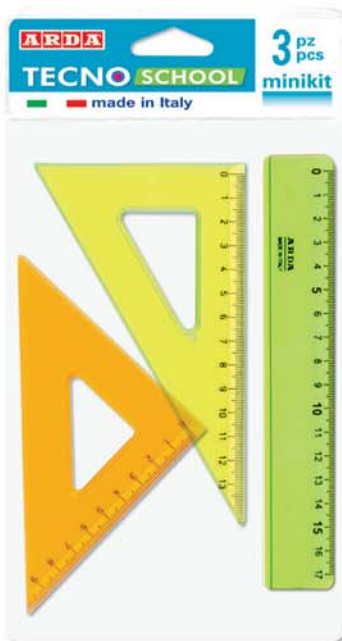

Ref. 7063FL
Miniset 3 pz/pcs :
45° 15cm
+ 60° 15cm
+ Riga 17cm



Colori assortiti
assorted colours - couleurs assorties



Art.	EAN13 art.	Descrizione / Description	INNER pz/pcs	EAN13 inner	MASTER pz/pcs
40016FLAS	8003438019264	Riga / Ruler / Règle cm.17	20	8003438019271	800
40030FLAS	8003438019097	Riga / Ruler / Règle cm.30	20	8003438019165	20
7063FL	8003438019134	Miniset 3 pz./pcs	20	8003438019196	20

Righe sfuse primo prezzo

First price rulers in bulk
Règles premier prix, en vrac

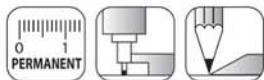

Ref. S10120X



Ref. S10130X

Art.	EAN13 art.	Descrizione / Description	INNER pcs	EAN13 inner	MASTER pcs
S10120X	8003438002426	cm. 20	50	8003438013668	2000
S10130X	8003438002402	cm. 30	50	8003438013675	1000

PICKITUP

Set disegno
4 pezzi

Drawing set - 4 pcs
Set de traçage - 4 pcs



Ref. 60420BIS

Art.	EAN13 art.	Descrizione / Description	INNER pcs	EAN13 inner	MASTER pcs
60420BIS	8003438604200	Set 4 pz : 45° 21 cm + 60° 21 cm + R30 cm + 180° 10 cm	50	8003438009432	50

MINI PICKITUP

Mini-set disegno
4 pezzi

Drawing miniset - 4 pcs
Miniset de traçage - 4 pcs

Ref. 704/12/4BL

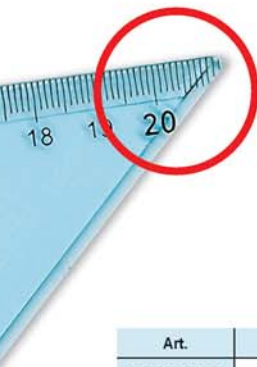

PUNTE ARROTONDATE
DI SICUREZZA

ROUND EDGES FOR
SECURITY

BOUTS RONDS POUR
PLUS DE SÉCURITÉ

Art.	EAN13 art.	Descrizione / Description	INNER pcs	EAN13 inner	MASTER pcs
704/12/4BL	8003438001924	MINI PICKITUP set 4 pz : 45°/12 cm + 60° 12cm + R15 + 180° 10 cm	50	8003438001191	300

Colori assortiti - Assorted colours - Couleurs assorties

ARDA

Pickitup
flex



INFRANGIBILE
SHATTERPROOF
INCASSABLE



Made in Italy
Italian quality & design

**INFRANGIBILE
SHATTERPROOF
INCASSABLE**

Squadra 45°

Set square 45°
Equerre 45°

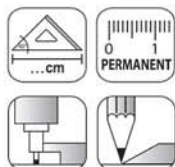

Smusso, tirachina e bordo interno
Bevelled edge, ink-edge and finger lift
Facette, bord anti-tache et bord
intérieur

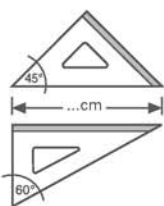

Ref. PKFL4520

Art.	EAN13 art.	Descrizione / Description	INNER pcs	EAN13 inner	MASTER pcs
PKFL4520	8003438021823	45° cm. 20	20	8003438021892	240

Squadra 60°

Set square 60°
Equerre 60°

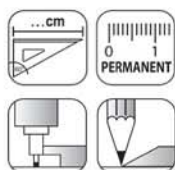

Smusso, tirachina e bordo interno
Bevelled edge, ink-edge and finger lift
Facette, bord anti-tache et bord
intérieur

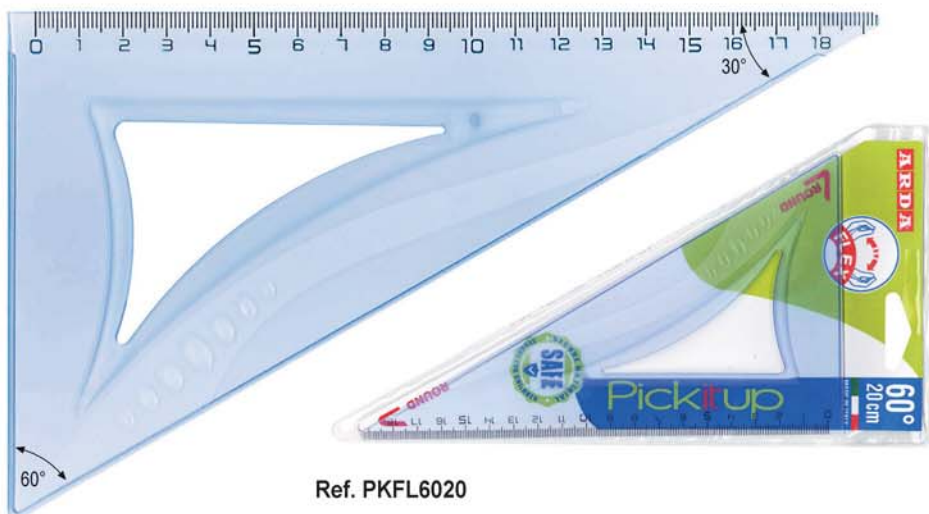

Ref. PKFL6020

Art.	EAN13 art.	Descrizione / Description	INNER pcs	EAN13 inner	MASTER pcs
PKFL6020	8003438021830	60° cm. 20	20	8003438021908	240

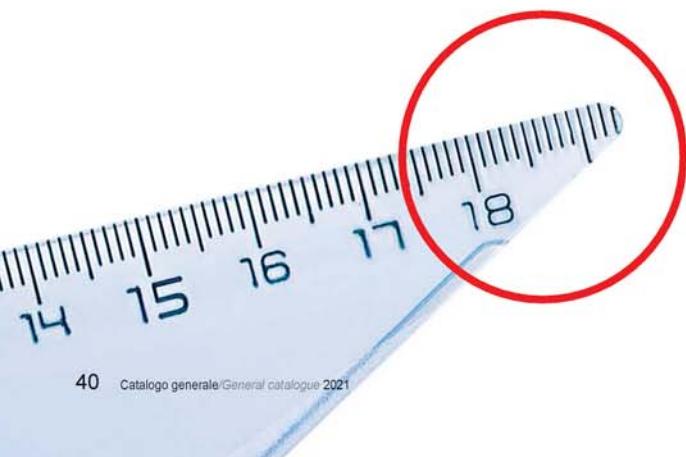

**PUNTE ARROTONDATE DI SICUREZZA
ROUND EDGES FOR SECURITY
BOUTS RONDS POUR PLUS DE SECURITÉ**

**INFRANGIBILE
SHATTERPROOF
INCASSABLE**

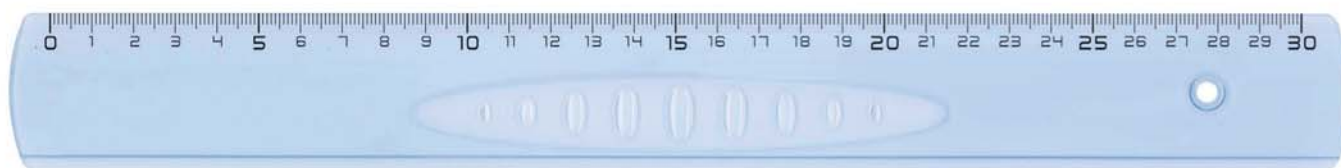

Ref. PKFL30

Riga
Ruler
Règle

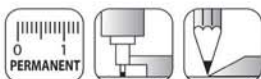

Smusso e tirachina
Bevelled edge and
ink-edge
Facette et bord
anti-tache

Art.	EAN13 art.	Descrizione / Description	INNER pcs	EAN13 inner	MASTER pcs
PKFL30	8003438021847	cm. 30	20	8003438021915	360

Doppio decimetro
Finger grip ruler 20cm
Double décimètre



Ref. PKFL20P



2 millimetrate.
Impugnatura corta
2 graduations. Short grip
2 graduations. Poignée
courte

Art.	EAN13 art.	Descrizione / Description	INNER pcs	EAN13 inner	MASTER pcs
PKFL20P	8003438021854	cm. 20	20	8003438021922	240

Goniometro 180°
Protractor 180°
Rapporteur 180°

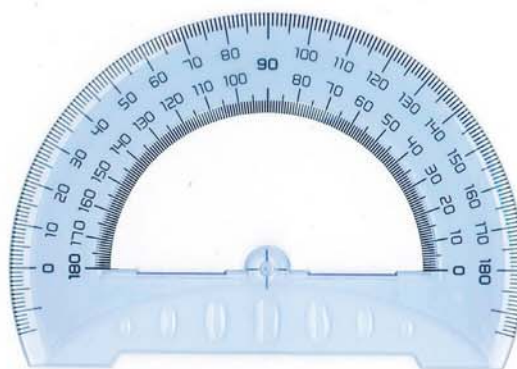
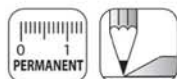

Ref. PKFL18012



Smusso e bordo interno
Bevelled edge and finger lift
Facette et bord intérieur

Art.	EAN13 art.	Descrizione / Description	INNER pcs	EAN13 inner	MASTER pcs
PKFL18012	8003438021861	180° cm. 12	20	8003438021939	400

**INFRANGIBILE
SHATTERPROOF
INCASSABLE**

Set disegno 4 pz

Drawing set 4 pcs

Set de traçage 4 pcs



* eccetto goniometro
except protractor - sauf que rapporteur

Smusso, tirachina e bordo interno
Bevelled edge, ink-edge and finger lift
Facette, bord anti-tache et bord intérieur



Ref. PKFLSET4

Art.	EAN13 art.	Descrizione / Description	INNER pcs	EAN13 inner	MASTER pcs
PKFLSET4	8003438021885	Set 4 pz : 45° cm.20 + 60° cm.20 + R30 + 180° cm.12	50	8003438021953	50

Made in Italy
Italian quality & design

**KEEP
COLOUR**

UN MONDO DI COLORI
A WORLD OF COLORS
UN MONDE DE COULEURS

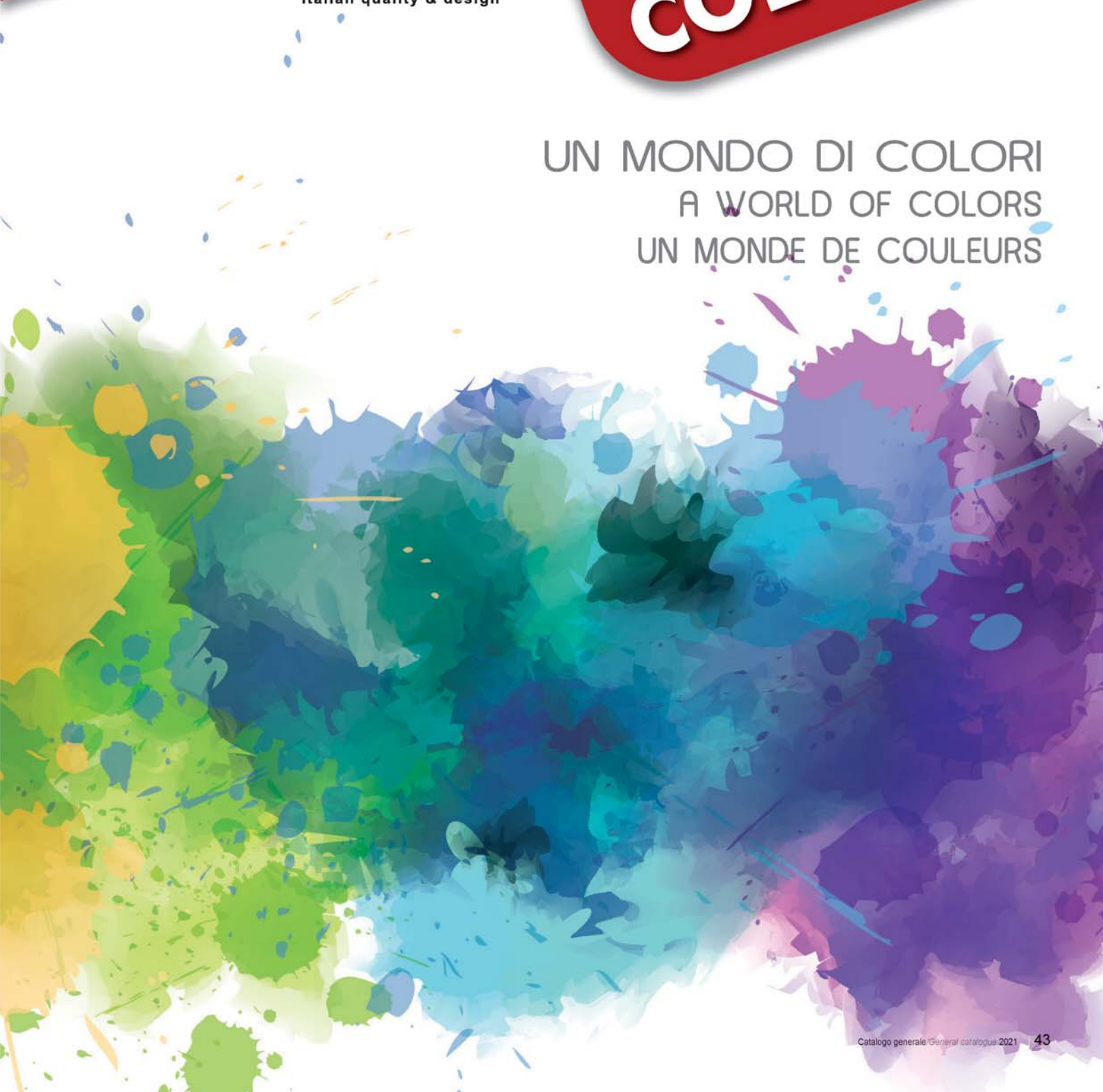

Tutto a POSTO e... tutto in ordine !

BUSTA PER RACCOGLITORE AD ANELLI

PORTA
CON TE IL
MINISET NEL
RACCOGLITORE
AD ANELLI



Made in Italy
Italian quality & design



Ref. KC7063

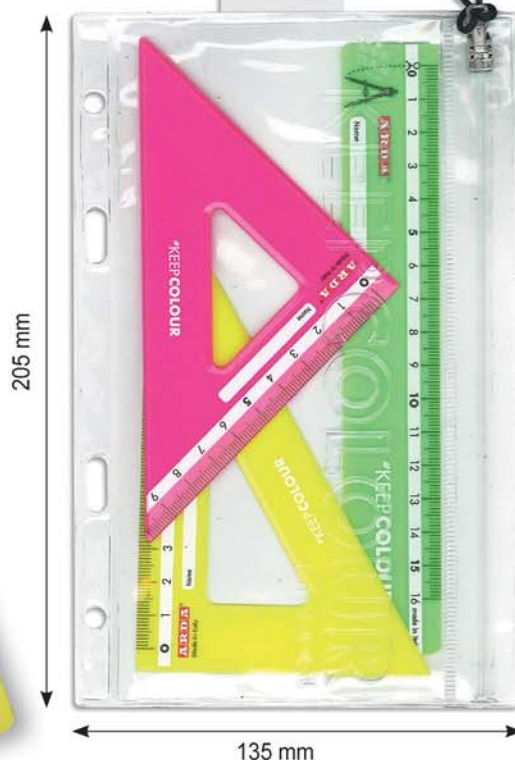

Foratura universale
Multi punches / Perforation universelle

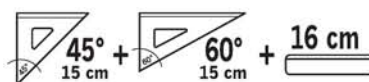

Miniset disegno in busta con zip

Drawing miniset in bag with zip - Miniset de traçage in pochette avec zip

Miniset da disegno in pratica busta con chiusura di sicurezza e preforatura per inserirla nel raccoglitore ad anelli e conservare in ordine gli strumenti da disegno.

Miniset for drawing in usefull bag with zip and holes for insert it in the ring binder and keep in order the drawing tools.

Miniset de traçage protégé dans une pratique pochette avec fermeture de sécurité et pré-perforation pour l'insérer dans le classeur anneau et garder en ordre les outils de dessin.

Art.	EAN13 art.	Descrizione / Description	INNER pcs	EAN13 inner	MASTER pcs
KC7063	8003438028181	Miniset disegno 3 pz/pcs : 45°cm.15 + 60°cm.15 + R16	10	8003438028228	10

Tutto a POSTO e... tutto in ordine !

ORGANIZER MULTITASCA PER GLI STRUMENTI DA DISEGNO

Made in Italy

Italian quality & design

**SUL RETRO
PUOI INSERIRE
ANCHE IL
TUO ALBUM
DISEGNO!**

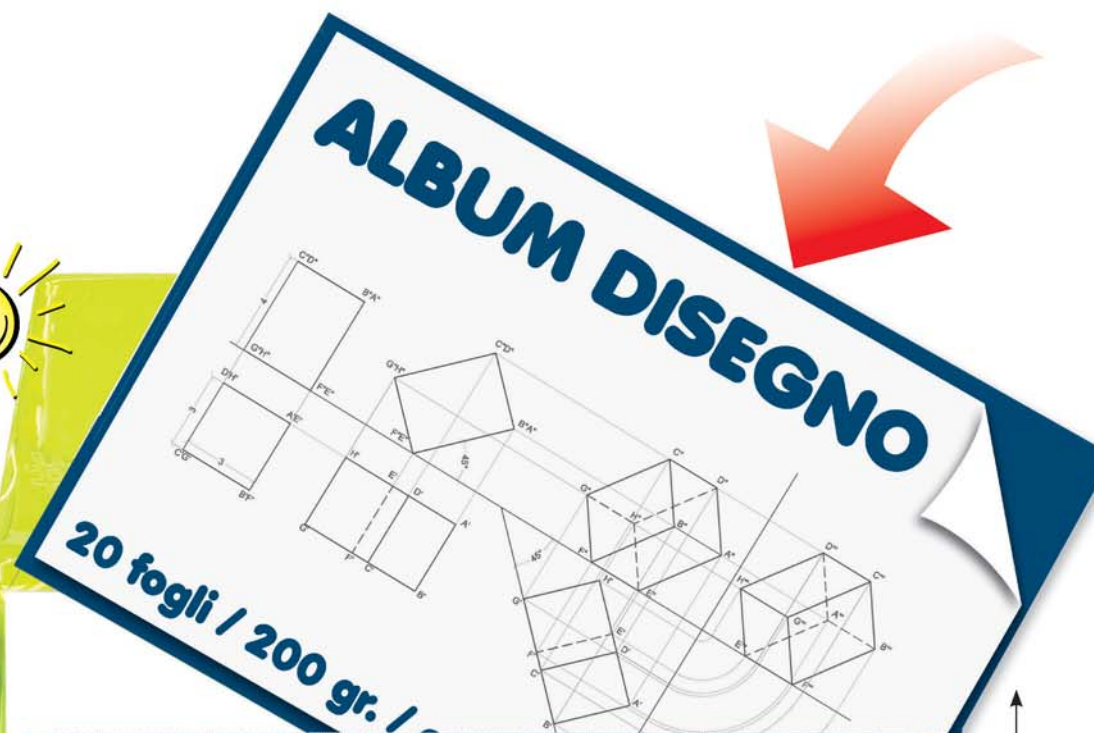

Ref. KC60430

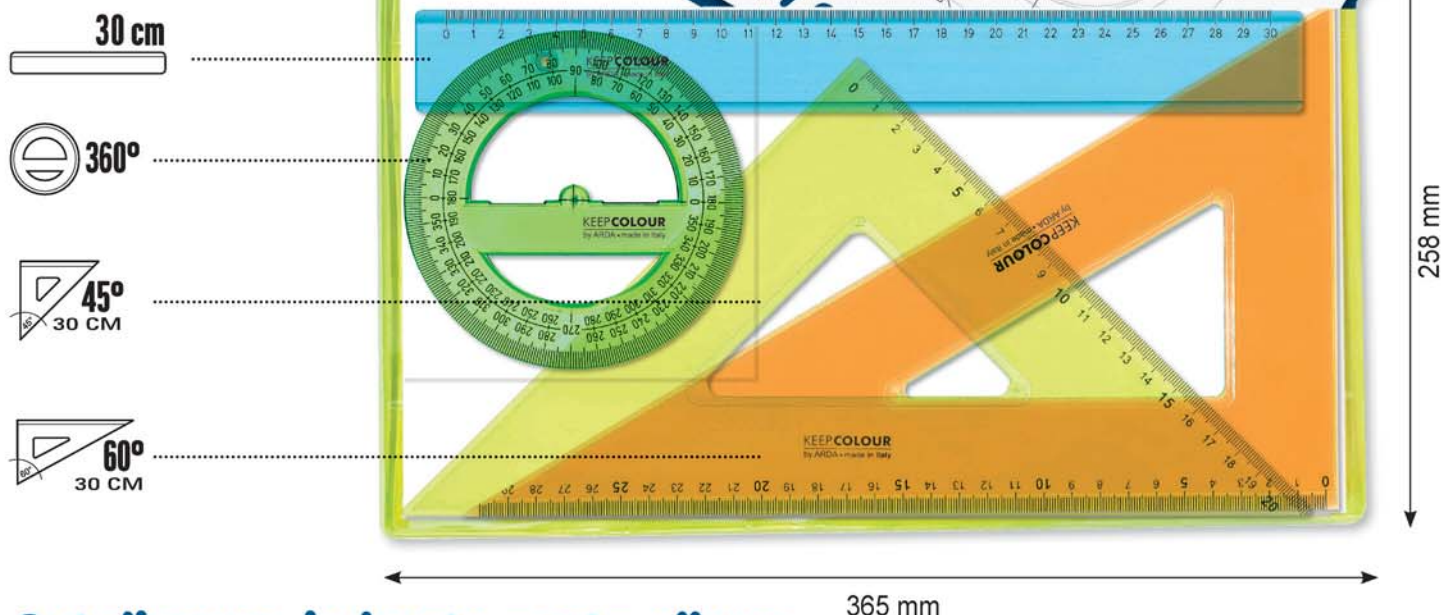

Set disegno in busta porta album

Drawing set in album holder envelope - Set de traçage dans une enveloppe porte papier à dessin

Custodia con gli articoli indispensabili per il disegno tecnico. Per ogni pezzo è prevista la sua sede e sul retro è prevista una tasca nella quale riporre l'album da disegno. Busta disponibile in 3 colori assortiti.

Smart case with essential items for technical drawing. For each piece there is its own place and on the back there is a pocket in which to store the sketchbook. Case in 3 fluo assorted colours.

Pochette avec les essentiels pour le dessin technique. Pour chaque pièce, il y a son propre siège et à l'arrière il y a une poche dans laquelle ranger le papier à dessin. Pochette en 3 couleurs assorties.

album non incluso - album not included - papier à dessin non inclus

Art.	EAN13 art.	Descrizione / Description	INNER pcs	EAN13 inner	MASTER pcs
KC60430	8003438028198	Set disegno 4 pz/pcs in busta porta album : 45°cm 30 + 60°cm.30 + R30 + 360° cm.12	10	8003438028235	10

Espositore FLUO

Display
Presentoir



72
pcs

Ref. 1630005



40 x 24 x 30 h. cm.



x 10



x 32



x 10



x 20

Art.	EAN13 art.	Descrizione / Description	INNER pcs	EAN13 inner	MASTER pcs
1630005	8003438028419	Display 72 pz contenente: - n°20 temperamatite SMART FLUO - n°32 righelli cm.16 FLUO - n°10 righe cm.30 FLUO - n°10 Miniset in busta con zip	1	8003438028419	1



Ref. KCP4766
35,5 x 24 x 57 h. cm

Espositore
Display
Presentoir

100
pcs



Contenuto specifico per disegno
tecnico su fogli A3

Specific content for technical drawing on A3
sheets

Contenu spécifique pour le dessin technique
sur papier A3

DISPLAY 100 pz / pcs

Art.	EAN13 art.	Descrizione / Description	INNER	MASTER
KCP4766	8003438022561	20x Sq. 45° cm. 30 20x Sq. 60° cm. 30 20x Righe cm. 50 10x Doppio dec. cm. 20 10x Triplo dec. cm. 30 20x Gon. 360° cm. 12	1	1

Disponibilità limitata alle campagne promozionali - Product availability limited to
promotional campaigns - Disponibilité limitée aux campagnes promotionnelles

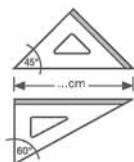

Ref. KCP4530

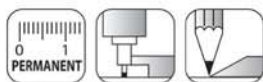

Smusso, tirachina e bordo interno
Bevelled edge, ink-edge and finger lift
Facette, bord anti-tache et bord intérieur



Ref. KCP6030



Ref. KCP50



Ref. KCP36012

Ref. KCCEO300



Ref. KCP20P



Ref. KCP30P



Art.	EAN13 art.	Descrizione / Description	INNER pz/pcs	EAN13 inner	MASTER pz/pcs
KCP4530	8003438 022578	Squadra / set square / Equerre 45° cm. 30	10	8003438 022646	10
KCP6030	8003438 022585	Squadra / set square / Equerre 60° cm. 30	10	8003438 022653	10
KCP50	8003438 022592	Riga / ruler / règle cm. 50	10	8003438 022660	10
KCP20P	8003438 022608	Doppio decimetro / Finger grip ruler cm.20 / Double décimètre	10	8003438 022677	10
KCP30P	8003438 022615	Triplo decimetro / Finger grip ruler cm.30 / Triple décimètre	10	8003438 022684	10
KCP36012	8003438 022622	Goniometro / Protractor / Rapporteur 360° 12cm	10	8003438 022691	10
KCCEO300	8003438 018724	GEO300 cm. 16	10	8003438 018762	350

Miniset disegno 3 pezzi

Drawing minikit 3 pcs
Mini presentoir de traçage 3 pcs



Smusso e tirachina
Bevelled edge and ink-edge
Facette et bord anti-tache



Ref. KCP7063DSS

Miniset:
- 45° cm.15
- 60° cm.15
- R16

Art.	EAN13 art.	Descrizione / Description	INNER pz/pcs	EAN13 inner	MASTER pz/pcs
KCP7063DSS	8003438 022530	Miniset 3 pcs : 45° cm.15 + 60° cm.15 + R16	20	8003438 022028	20



Espositore 48 righelli 16 cm

Display 48 pcs. Ruler 16 cm.
Presentoir 48 pcs. Règle 16 cm.

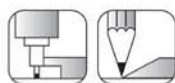

Smusso e tirachina
Bevelled edge and ink-edge
Facette et bord anti-tache



48
pcs

Ref. KCP17DESP
24,6 x 6,7 x 19 h. cm



Art.	EAN13 art.	Descrizione / Description	INNER pz/pcs	EAN13 inner	MASTER pz/pcs
KCP17DESP	8003438 022547	Display 48 pz - R16 cm (Ean pz 8003438 022554)	1	8003438 022547	1

Isoteck
® plexiglas

**PROFESSIONAL
HIGH QUALITY**

**MATERIALE ACRILICO
® plexiglas**

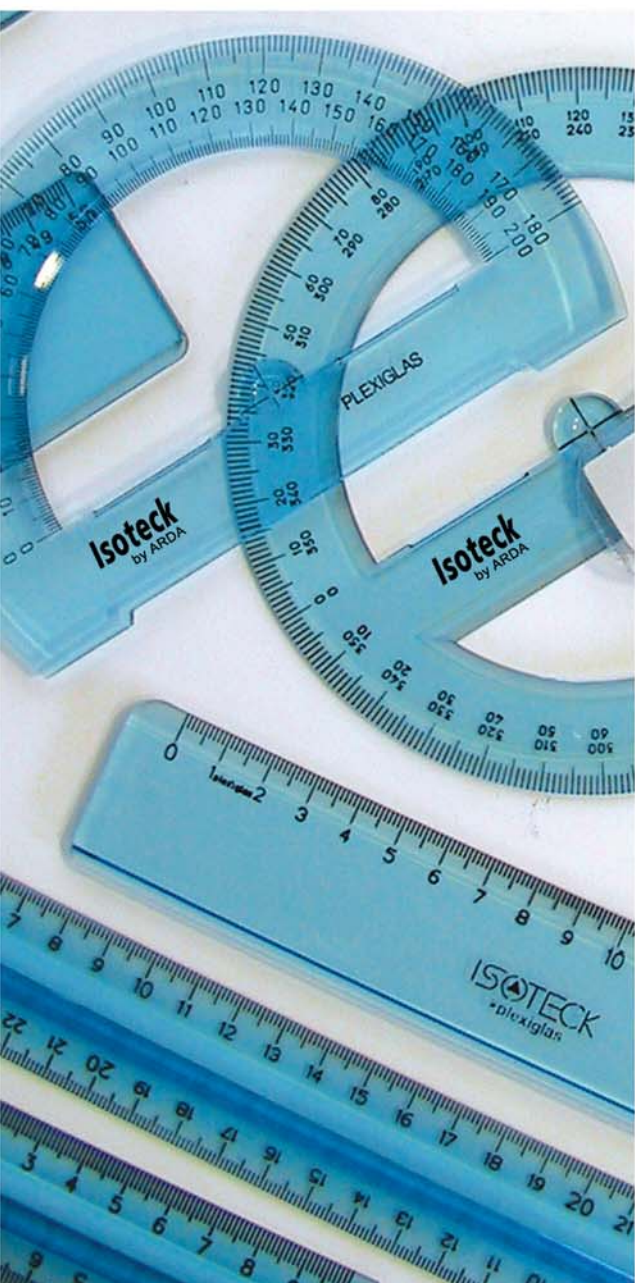

**PER IL DISEGNO TECNICO
SPECIALIZZATO.**

**FOR SPECIALIST TECHNICAL DRAWING.
POUR LE DESSIN TECHNIQUE EN ACRYLIQUE.**

Made in Italy
Italian quality & design

É la serie di precisione per il disegno tecnico specializzato. Il materiale impiegato è il PLEXIGLAS®, resistente agli urti e ai graffi e di massima trasparenza. La graduazione è incisa ed indelebile.

Specific line for technical drawing. Is injected in PLEXIGLAS® material, strong and extra transparent. The graduation is etched and indelible.

Gamme de traçage pour le dessin technique. La matière employé est le PLEXIGLAS®, très resistente et de haute transparence. La gravure de la graduation est indélébile.

PROFESSIONAL - HIGH QUALITY

Squadre

Set square
Equerre

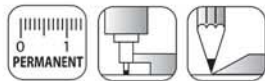

Smusso, tirachina e bordo interno
Bevelled edge, ink-edge and finger lift
Facette, bord anti-tache et bord intérieur

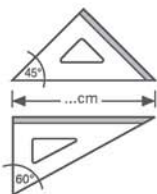

Ref. 73012 - 16 - 21 -
26 - 32 - 37 - 42 - 50

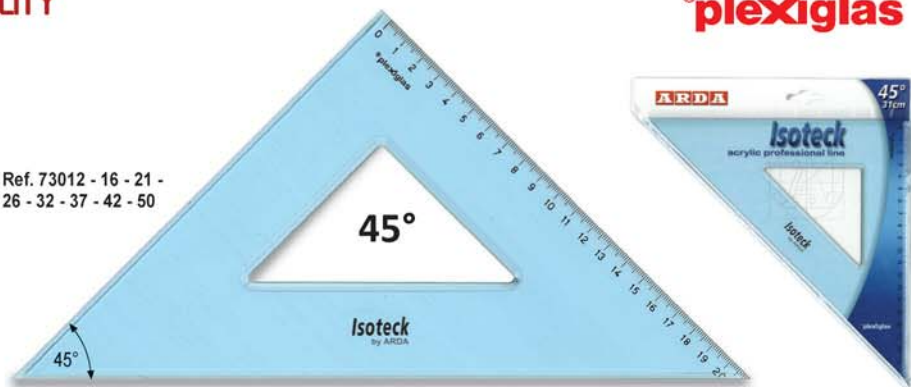

Art.	EAN13 art.	Descrizione / Description	INNER pcs	EAN13 inner	MASTER pcs
73012	8003438730121	45° cm. 12	10	8003438732125	10
73016	8003438730169	45° cm. 16	10	8003438732163	10
73021	8003438730213	45° cm. 21	10	8003438732217	10
73026	8003438730268	45° cm. 26	10	8003438732262	10
73032	8003438730329	45° cm. 31	10	8003438732323	10
73037	8003438730374	45° cm. 36	10	8003438732378	10
* 73042	8003438730428	45° cm. 42	10	8003438732422	10
* 73050	8003438730503	45° cm. 50	10	8003438732507	10

* Ricavate da lastra - Cut from plate
Découpé à partir de la plaque

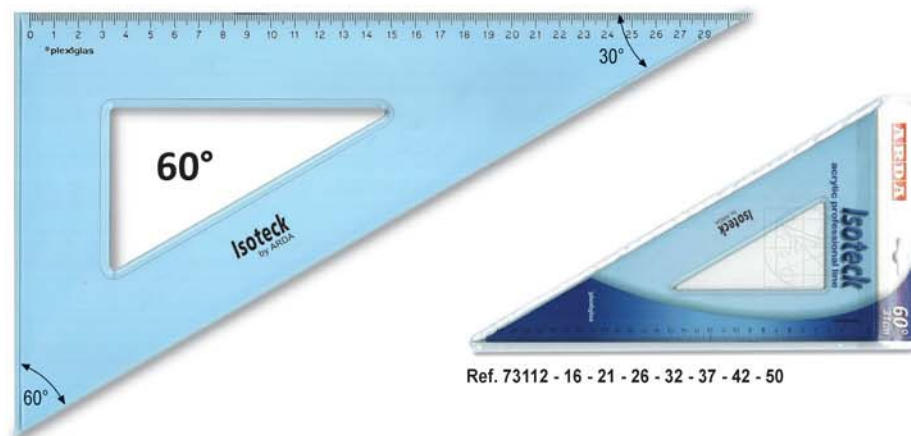

Ref. 73112 - 16 - 21 - 26 - 32 - 37 - 42 - 50

Art.	EAN13 art.	Descrizione / Description	INNER pcs	EAN13 inner	MASTER pcs
73112	8003438731128	60° cm. 12	10	8003438733122	10
73116	8003438731166	60° cm. 16	10	8003438733160	10
73121	8003438731210	60° cm. 21	10	8003438733214	10
73126	8003438731265	60° cm. 26	10	8003438733269	10
73132	8003438731326	60° cm. 31	10	8003438733320	10
73137	8003438731371	60° cm. 36	10	8003438733375	10
* 73142	8003438731425	60° cm. 42	10	8003438733429	10
* 73150	8003438731500	60° cm. 50	10	8003438733504	10

Righe

Rulers
Règles

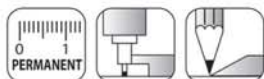

Smusso e tirachina
Bevelled edge and ink-edge
Facette et bord anti-tache

* Ricavate da lastra - Cut from plate
Découpé à partir de la plaque



Ref. 70030 - 50 - 60 - 70 - 80 - 120 - 150



Art.	EAN13 art.	Descrizione / Description	INNER pcs	EAN13 inner	MASTER pcs
70030	8003438700308	cm. 30	10	8003438710307	10
70050	8003438700506	cm. 50	10	8003438710505	10
70060	8003438700605	cm. 60	10	8003438710604	10
70070	8003438700704	cm. 70	10	8003438710703	10
70080	8003438700803	cm. 80	10	8003438710802	10
* 700120	8003438700124	cm. 120	1	8003438700124	5
* 700150	8003438700155	cm. 150	1	8003438700155	5

PROFESSIONAL - HIGH QUALITY

Ref. 70150 - 60 - 70 - 80 - 100 - 120

Righe per parallelografi

Parallel rulers
Règles pour parallèles

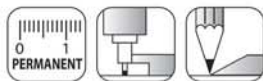

Guscette in plexiglas per scorrimento a filo
Plexiglas slide-guides for thread
Glissières en plexiglas pour fil

Smusso e tirachina
Bevelled edge and ink-edge
Facette et bord anti-tache

Art.	EAN13 art.	Descrizione / Description	INNER pcs	EAN13 inner	MASTER pcs
70150	8003438701503	cm. 50	1	8003438701503	10
70160	8003438701602	cm. 60	1	8003438701602	10
70170	8003438701701	cm. 70	1	8003438701701	10
70180	8003438701800	cm. 80	1	8003438701800	10
* 701100	8003438701107	cm. 100	1	8003438701107	10
* 701120	8003438701121	cm. 120	1	8003438701121	10

* Ricavate da lastra - Cut from plate
Découpé à partir de la plaque

Doppio e Triplo decimetro

Finger grip ruler 20-30cm
Double e triple décimètre



2 millimetature. Impugnatura lunga.
2 graduations. Long grip.
2 graduations. Longue poignée.



Ref. 68020



Ref. 68030



Art.	EAN13 art.	Descrizione / Description	INNER pcs	EAN13 inner	MASTER pcs
68020	8003438680204	cm. 20	10	8003438681201	10
68030	8003438680303	cm. 30	10	8003438681300	10

Goniometri

Protractor
Rapporteur

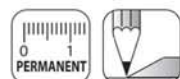

Smusso e bordo interno
Bevelled edge and finger lift
Facette et bord intérieur



Ref. 750

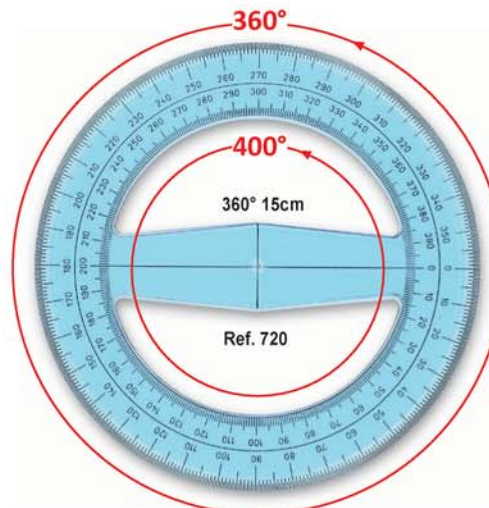

Ref. 720



Art.	EAN13 art.	Descrizione / Description	INNER pcs	EAN13 inner	MASTER pcs
750	8003438007506	180° cm. 15	10	8003438107503	10
720	8003438007209	360° cm. 15	10	8003438107206	10

PROFESSIONAL - HIGH QUALITY

Righe T

T-squares
Règle à "T"

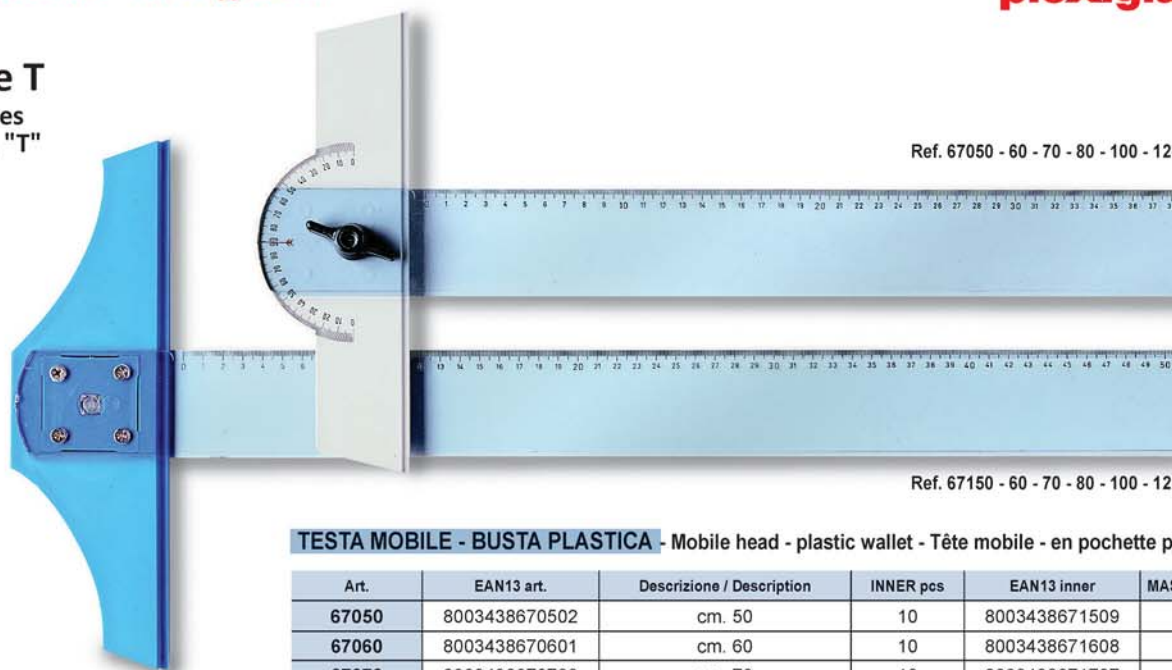

Ref. 67050 - 60 - 70 - 80 - 100 - 120

Ref. 67150 - 60 - 70 - 80 - 100 - 120

TESTA MOBILE - BUSTA PLASTICA - Mobile head - plastic wallet - Tête mobile - en pochette plastique

Art.	EAN13 art.	Descrizione / Description	INNER pcs	EAN13 inner	MASTER pcs
67050	8003438670502	cm. 50	10	8003438671509	10
67060	8003438670601	cm. 60	10	8003438671608	10
67070	8003438670700	cm. 70	10	8003438671707	10
67080	8003438670809	cm. 80	10	8003438671806	10
* 670100	8003438670106	cm. 100	1	8003438670106	10
* 670120	8003438670120	cm. 120	1	8003438670120	10

* Ricavate da lastra. Riga colore cristallo.
Cut from plate. Crystal color ruler.
Découpé à partir de la plaque. Règle de couleur cristal.

TESTA FISSA - BUSTA CELLOPHANE - Fixed head - cellophane wallet - Tête fixe en pochette cellophane

Art.	EAN13 art.	Descrizione / Description	INNER pcs	EAN13 inner	MASTER pcs
67150	8003438671516	cm. 50	10	8003438067159	10
67160	8003438671615	cm. 60	10	8003438067166	10
67170	8003438671714	cm. 70	10	8003438067173	10
67180	8003438671813	cm. 80	10	8003438067180	10
* 671100	8003438711007	cm. 100	1	8003438711007	10
* 671120	8003438711212	cm. 120	1	8003438711212	10



45
pcs

Ref. 641
35,5 x 24 x 63. h. cm

Espositore

Display
Presentoir

DISPLAY 45 pz / pcs

Art.	EAN13 art.	Descrizione / Description	INNER	MASTER
641	8003438013620	5x Sq. 45° cm. 31 5x Sq. 60° cm. 31 5x Sq. 45° cm. 36 5x Sq. 60° cm. 36 5x Righe cm. 50 5x Righe cm. 60 5x Doppio dec. cm. 20 5x Triplo dec. cm. 30 5x Gon. 180° cm. 15	1	1

Disponibilità limitata alle campagne promozionali - Product availability limited to promotional campaigns - Disponibilité limitée aux campagnes promotionnelles



Contenuto specifico per disegno tecnico su fogli A3

Specific content for technical drawing on A3 sheets
Contenu spécifique pour le dessin technique sur papier A3

Righe speciali 35 cm

Specific rulers 35 cm
Règles spéciales 35 cm

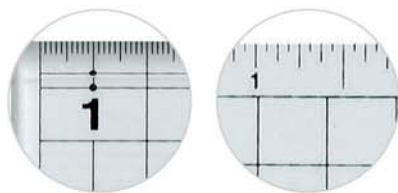

Ref. 97035

Art.	EAN13 art.	Descrizione / Description	INNER pcs	EAN13 inner	MASTER pcs
97035	8003438970350	cm. 5 x 35	10	8003438971357	10

Righe per tabulati

Ruler for records reading
Règle pour la lecture des textes

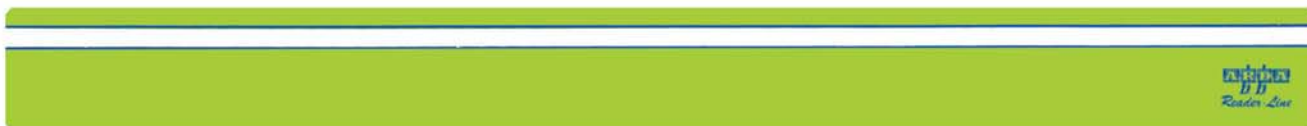

Ref. 389

Art.	EAN13 art.	Descrizione / Description	INNER pcs	EAN13 inner	MASTER pcs
389	8003438389008	cm. 40	20	8003438389107	20

Curvilinee deformabili millimetrata

Flexible curves with graduation
Règles flexibles avec graduation



Tirachina
Ink-edge
Anti-tache

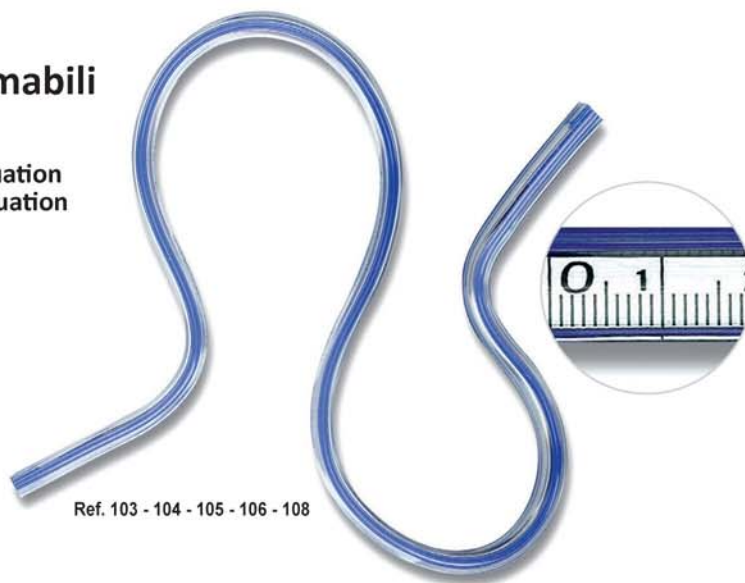

Ref. 103 - 104 - 105 - 106 - 108



Art.	EAN13 art.	Descrizione / Description	INNER pcs	EAN13 inner	MASTER pcs
103	8003438001030	cm. 30	10	8003438101037	10
104	8003438001047	cm. 40	10	8003438101044	10
105	8003438001054	cm. 50	10	8003438101051	10
106	8003438001061	cm. 60	10	8003438101068	10
108	8003438001085	cm. 90	10	8003438101082	10

Scalimetri in alluminio

Triangular scale in aluminium
Echelle rd réduction en aluminium

7 SCALE - MINIMO INGOMBRO
7 SCALES - MINIMUM ROOM • 7 ECHELLES - SPACE MINIMUM



Ref. 113



Ref. 114



Uso edilizia
For building purposes
Pour constructions
1:100-200-250-300-400-500-600

Sezione piatta con canaline colorate
Flat section with coloured grooves
Section plate avec rainures en couleurs divers

Art.	EAN13 art.	Descrizione / Description	INNER pcs	EAN13 inner	MASTER pcs
114	8003438003737	cm.15	1	8003438003737	12
113	8003438003713	cm.30	1	8003438003713	12

Scalimetri in plastica

Triangular scale in plastic
Echelle rd réduction en plastique

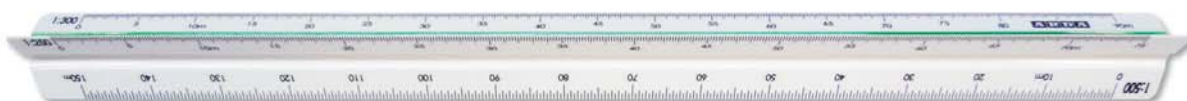

Ref. 109 **A** Uso edilizia - For building purposes - Pour construction
1:100 - 200 - 250 - 300 - 400 - 500



Ref. 110 **B** Uso arredamento - For furnishing purposes - Pour ameublement
1:20 - 25 - 50 - 75 - 100 - 125



Ref. 111 **C** Uso catasto - For land registry purposes - Pour Cadastral
1:500 - 1000 - 1250 - 1500 - 2000 - 2500



Sezione triangolare con canaline colorate
Triangular section with coloured grooves
Section triangulaire avec rainures en couleurs divers

	Art.	EAN13 art.	Descrizione / Description	INNER pcs	EAN13 inner	MASTER pcs
A	109	8003438001092	EDILIZIA cm.30	1	8003438001092	12
B	110	8003438001108	ARREDAMENTO cm.30	1	8003438001108	12
C	111	8003438001115	CATASTO cm. 30	1	8003438001115	12

ARDA



STRUMENTI PER
IL CARTEGGIO NAUTICO.

EQUIPMENT FOR NAUTICAL
CARTOGRAPHY.

INSTRUMENTS POUR LES
MAPPES DE NAVIGATION.

Made in Italy

Italian quality & design

Squadre nautiche

45° 26 cm

Set square 45° 26 cm
Equerres 45° 26 cm

plexiglas

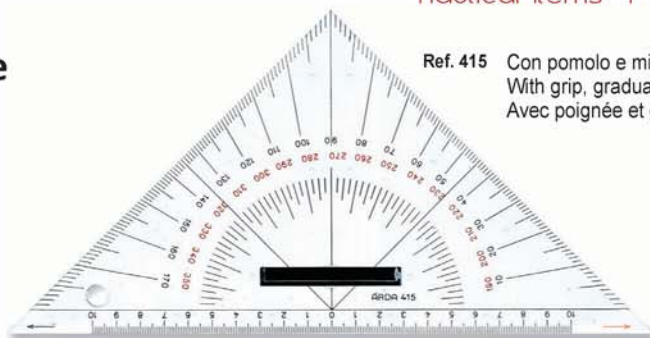

Ref. 415 Con pomolo e millimetratura con linea di fede.
With grip, graduated with hypotenuse scale detached from edge.
Avec poignée et graduation hypotenuse détachée du bord.

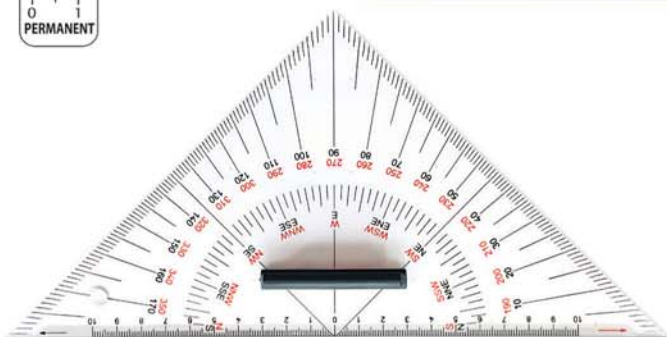

Ref. 416 Con pomolo, millimetrata con linea di fede sul bordo
With grip, graduated with hypotenuse scale on the edge.
Avec poignée et graduation hypotenuse sur le bord.



Ref. 417 Neutra con pomolo - Without graduation, with handle - Non-graduée, avec poignée

Art.	EAN13 art.	Descrizione / Description	INNER pcs	EAN13 inner	MASTER pcs
415	8003438415004	45° cm.26	10	8003438415011	200
416	8003438416001	45° cm.26	10	8003438416018	200
417	8003438417008	45° cm.26	10	8003438417015	200

Squadre nautiche

45° 32 cm

Set square 45° 32 cm
Equerres 45° 32 cm

plexiglas

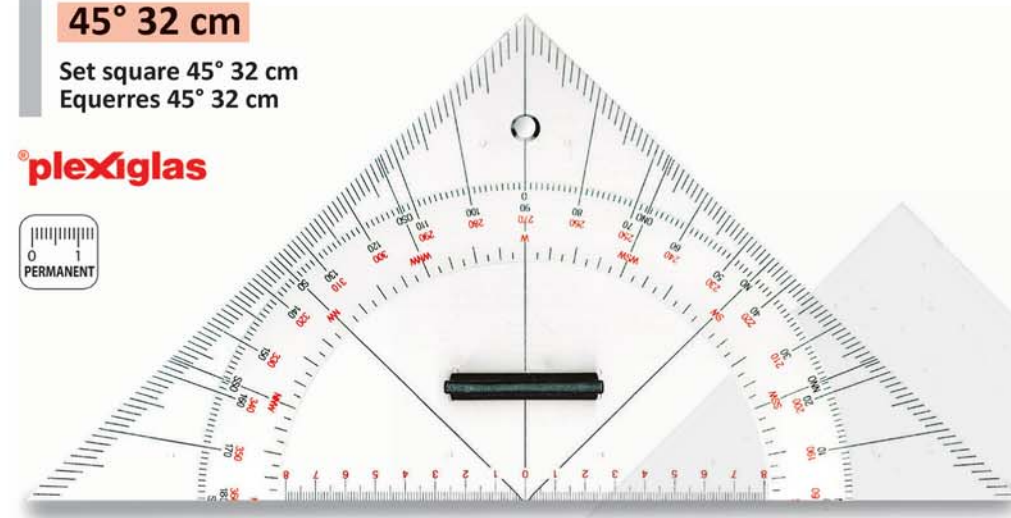

Ref. 418
Con pomolo, millimetrata con linea di fede sul bordo
With grip, graduated with hypotenuse scale on the edge.
Avec poignée et graduation hypotenuse sur le bord.

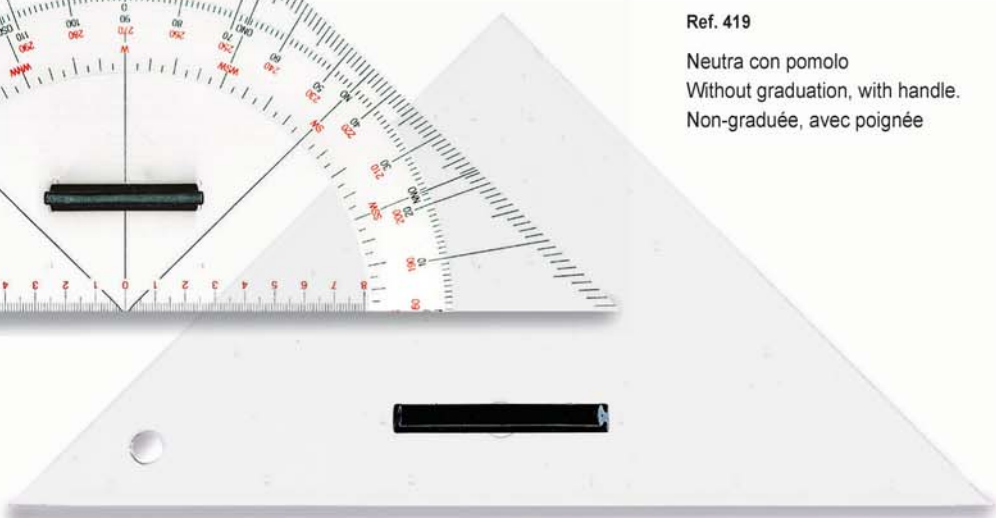

Ref. 419
Neutra con pomolo
Without graduation, with handle.
Non-graduée, avec poignée

Art.	EAN13 art.	Descrizione / Description	INNER pcs	EAN13 inner	MASTER pcs
418	8003438418005	45° cm.32	10	8003438418012	100
419	8003438419002	45° cm.32	10	8003438419019	100

Righe a rullo

Rolling ruler
Règle roulante

plexiglas

Rulli in ottone con gomma antiscivolo
Brass roller with no-sliding rubber
Rouleau en laiton avec gomme
antidérapant

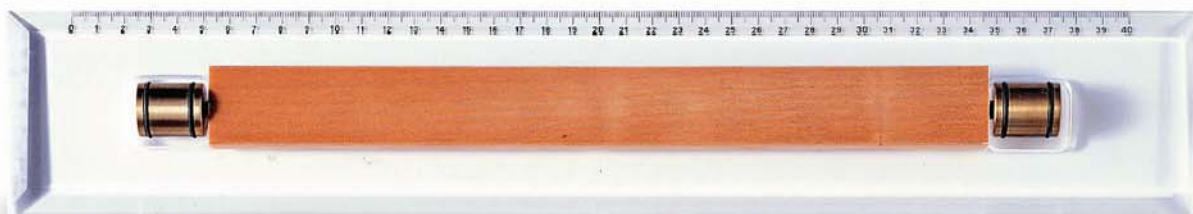

Ref. 328

Art.	EAN13 art.	Descrizione / Description	INNER pcs	EAN13 inner	MASTER pcs
328	8003438328014	cm. 40	1	8003438328014	1

Righe parallele

Parallel rulers
Règles parallèles

Ref. 325SC

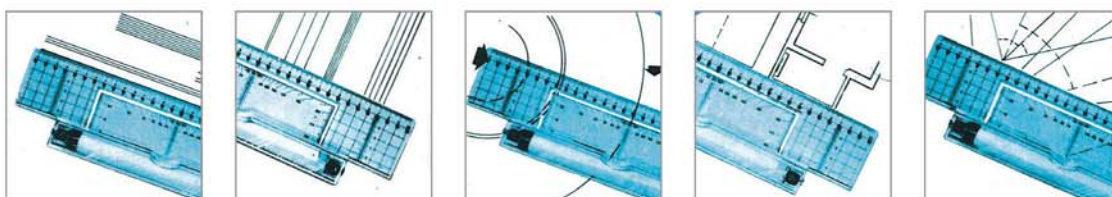
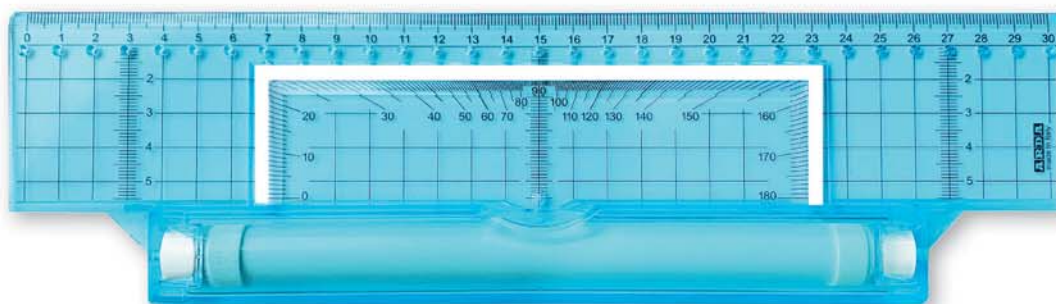

Art.	EAN13 art.	Descrizione / Description	INNER pcs	EAN13 inner	MASTER pcs
325SC	8003438325006	cm.30	1	8003438325006	5

Compasso nautico

Nautical compass
Compas nautique

Compasso in zama
Zama compass
Compas de zama

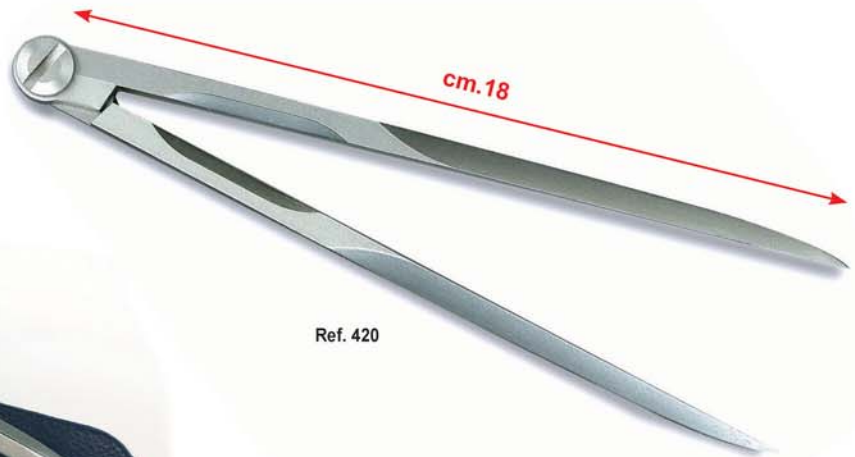

Ref. 420

Art.	EAN13 art.	Descrizione / Description	INNER pcs	EAN13 inner	MASTER pcs
420	8003438420008	Compasso nautico	1	8003438420008	10

Goniometri

Protractor
Rapporteur

plexiglas

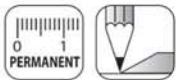

Smusso e bordo interno
Bevelled edge and finger lift
Facette et bord intérieur



Ref. 750

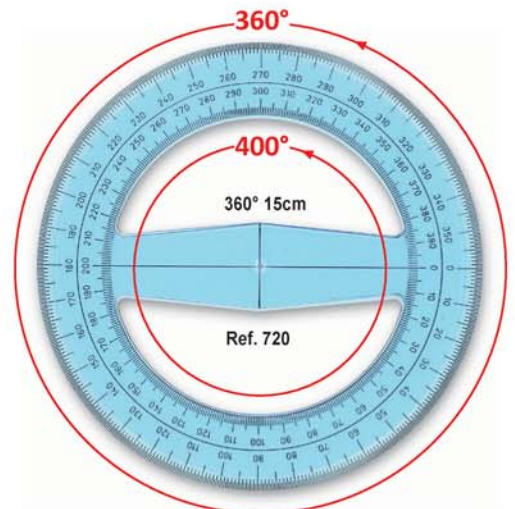

Ref. 720

Art.	EAN13 art.	Descrizione / Description	INNER pcs	EAN13 inner	MASTER pcs
750	8003438007506	180° cm. 15	10	8003438107503	10
720	8003438007209	360° cm. 15	10	8003438107206	10

Made in Italy



Righe

Rulers
Règles

Bordo tirachina - graduazione fotoincisa
bordi rettificati
Ink-edge - Photo-engraved graduation -
Bevelled edge
Bord anti-tache - Graduation photo-gra-
vée - Facette

Ref. 52030 - 80 - 100



Profilo di plastica integrato per resistere ai lavori di taglio
Integrated plastic profile to resist cutting jobs
Profil en plastique intégré pour résister aux travaux de coupe

Art.	EAN13 art.	Descrizione / Description	INNER pcs	EAN13 inner	MASTER pcs
52030	8003438520302	cm. 30	1	8003438520302	10
52080	8003438520807	cm. 80	1	8003438520807	10
520100	8003438520104	cm. 100	1	8003438520104	10

Doppio e Triplo decimetro

Finger grip ruler 20-30cm
Double e triple décimètre

Graduazione fotoincisa bordi rettificati
Photo-engraved graduation
Bevelled edge
Graduation photo-gravée - Facette

Ref. 522



Ref. 523



Art.	EAN13 art.	Descrizione / Description	INNER pcs	EAN13 inner	MASTER pcs
522	8003438005229	cm. 20	1	8003438005229	10
523	8003438005236	cm. 30	1	8003438005236	10

Tavoletta per disegno (parallelografi)

Drawing boards (parallelograph)
Tables à dessin (parallélographe)



Con leggio
with stand - avec lutrin

Scorrimento a filo.
Sliding with thread.
Glissement à fil.



Art.	EAN13 art.	F.to / size	INNER	EAN13 inner	MASTER
050M	8003438014153	cm.40x53	1	8003438014153	8
060M	8003438014207	cm.48x63	1	8003438014207	7
070M	8003438014214	cm.50x73	1	8003438014214	5

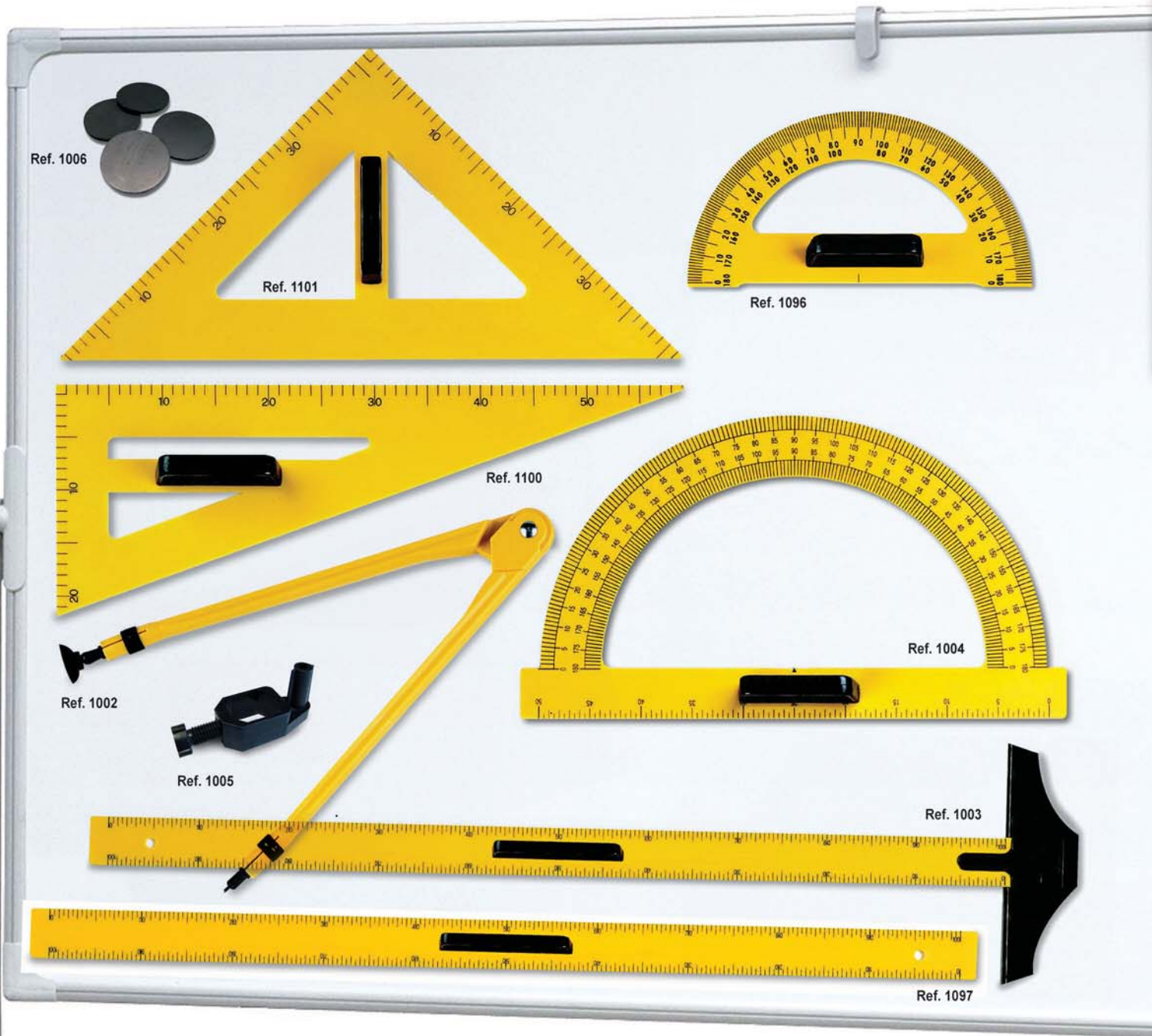

in plastica - in plastic - en plastique

Art.	EAN13 art.	Descrizione / Description	INNER pcs	EAN13 inner	MASTER pcs
1100	8003438011008	Squadra / set square / equerre 70° cm. 60	1	8003438011008	50
1101	8003438011015	Squadra / set square / equerre 45° cm. 60	1	8003438011015	50
1096	8003438010964	Goniometro / protractor / rapporteur 180° cm.35	1	8003438010964	50
1004	8003438010049	Goniometro / protractor / rapporteur 180° cm.50	1	8003438010049	50
1097	8003438010971	Riga / ruler / règle cm. 100	1	8003438010971	25
1003	8003438010032	Riga T / T ruler / règle "T" cm.100	1	8003438010032	50
1002	8003438010025	Compasso / compass / compas cm. 35	1	8003438010025	5
1005	8003438010056	Adattatore per compasso compass adaptor / adaptateur pour compas	1	8003438010056	50
1006	8003438010063	Set 4 calamite / set 4 magnets / set 4 aimants	20	8003438110060	20

**Aluminium****ALLUMINIO ANODIZZATO
CLASSICO E COLORATO****ANODIZED ALUMINUM
CLASSIC AND COLORFUL****ALUMINIUM ANODISÉ
CLASSIQUE ET COLORÉ**

Gli articoli di alluminio sono nati come strumenti professionali e si sono poi largamente diffusi come prodotti scolastici grazie alla robustezza e solidità dell'alluminio.

The articles of aluminium were conceived as professional tools and have been widely used as educational products thanks to the strength and stability of aluminium.

Les articles en aluminium sont nés comme un outil professionnel et ont été largement utilisés comme produits éducatifs grâce à la robustesse et la solidité de l'aluminium.

Aluminium Frost

Barattoli righelli - 24 pz.

pot containing rulers - 24 pcs

Pots de règle - 24 pcs

15 cm



20 cm

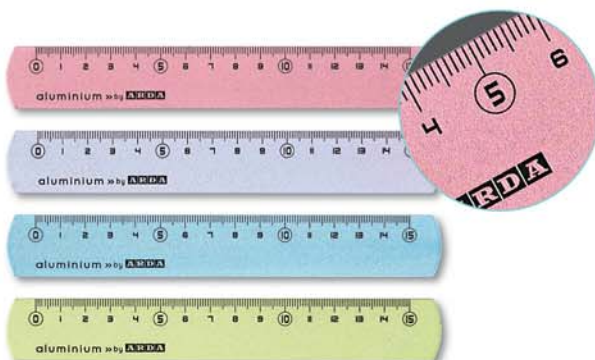

24 pcs



Ref. 17815COLBAR

24 pcs

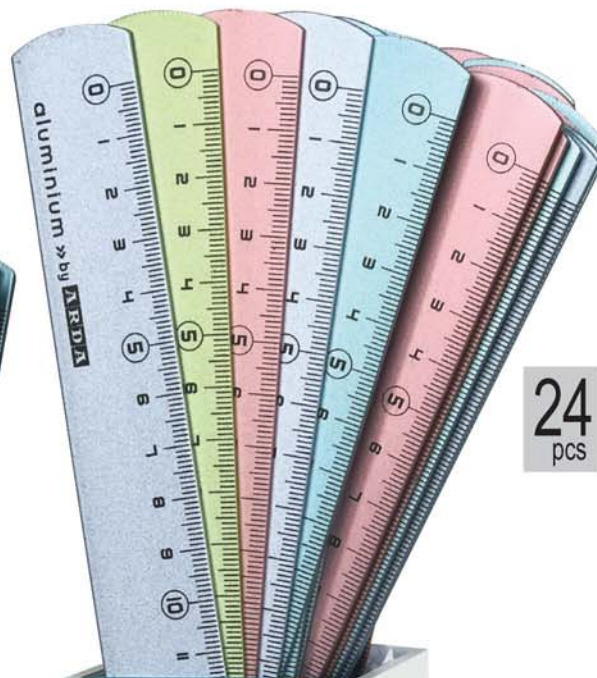

Ref. 17820COLBAR

Art.	EAN13 art.	Descrizione / Description	INNER pcs	EAN13 inner	MASTER pcs
17815COLBAR	8003438022127	Barattolo 24 righelli alu cm. 15 - col. ass. (ean pz 8003438022189)	1	8003438022127	10
17820COLBAR	8003438022134	Barattolo 24 righelli alu cm. 20 - col. ass. (ean pz 8003438 022196)	1	8003438022134	10

colori assortiti - assorted colours - couleurs assorties

Aluminium Frost

Espositore
Display
Presentoir

Ean singolo/per item/à l'unité



40
pcs



Ref. 178SQ

Art.	EAN13 art.	Descrizione / Description	INNER pcs	EAN13 inner	MASTER pcs
178SQ	8003438027894	Display 40 pz colori assortiti: - 20 pz 45° cm.12 (ean pz 8003438 023285) - 20 pz 60° cm.12 (ean pz 8003438 023292)	1	8003438027894	1

colori assortiti - assorted colours - couleurs assorties

Temperamatite in metallo

Metal pencil sharpener
Taille-crayons en metal

**METAL
COLOUR**

Ref. M021SC
Display 24 pcs

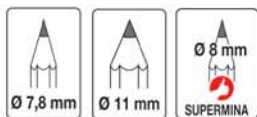

Art.	EAN13 art.	Descrizione / Description	INNER pcs	EAN13 inner	MASTER pcs
M021SC	8003438028396	Temperamatite in metallo colorato in display 24 pz - col. ass. (ean display 8003438 023438)	24	8003438023438	720

colori assortiti - assorted colours - couleurs assorties

Aluminium PROFIL

Squadre 45°

Set square 45°
Equerre 45°

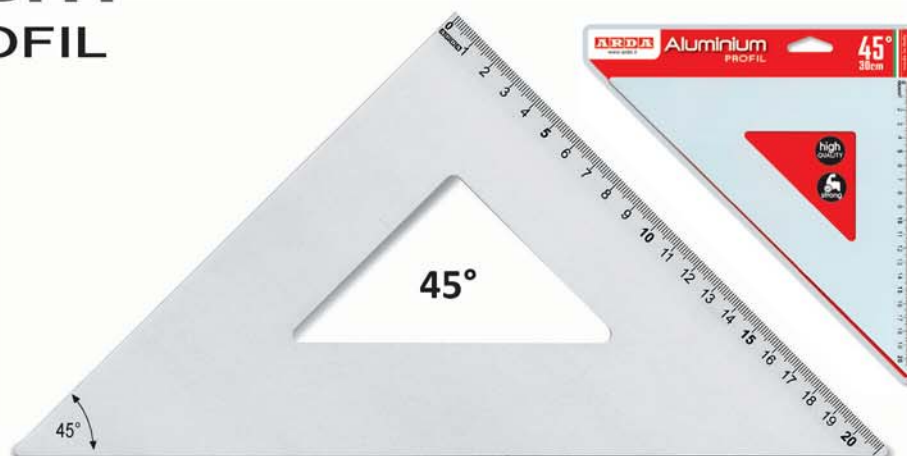

Ref. 18026 - 32 - 40

Art.	EAN13 art.	Descrizione / Description	INNER pcs	EAN13 inner	MASTER pcs
18026	8003438180261	45° cm.25	3	8003438188267	30
18032	8003438180322	45° cm. 30	3	8003438188328	30
18040	8003438180407	45° cm. 35	3	8003438188403	3

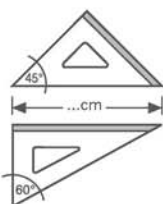

Squadre 60°

Set square 60°
Equerre 60°

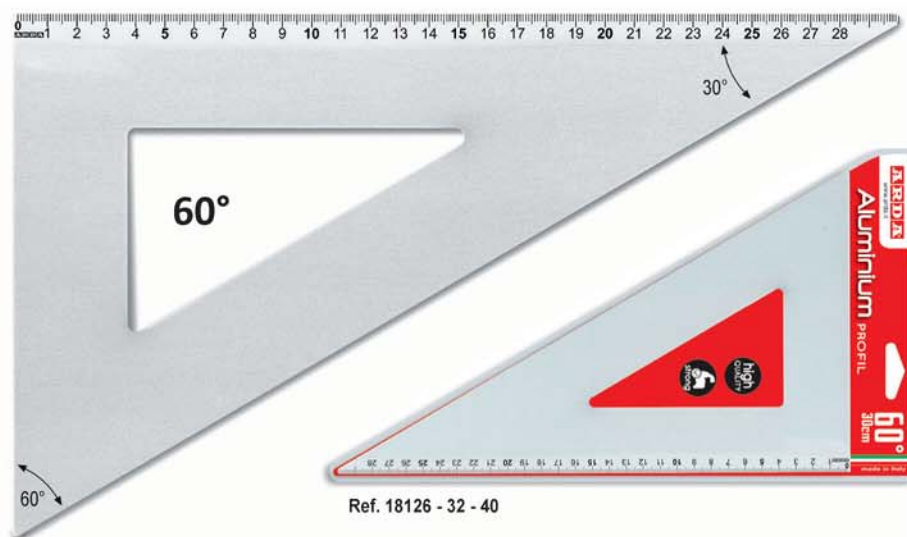
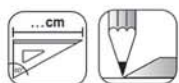

Ref. 18126 - 32 - 40

Art.	EAN13 art.	Descrizione / Description	INNER pcs	EAN13 inner	MASTER pcs
18126	8003438181268	60° cm. 25	3	8003438189264	30
18132	8003438181329	60° cm. 30	3	8003438189325	30
18140	8003438181404	60° cm. 35	3	8003438189400	3

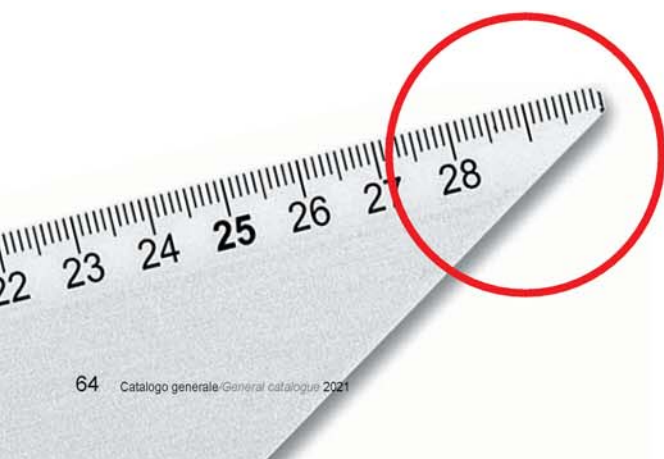

PUNTE ARROTONDATE DI SICUREZZA
ROUND EDGES FOR SECURITY
BOUTS ROUNDS POUR PLUS DE SECURITÉ

Righe

Rulers
Règles

Ref. 18230 - 40 - 50 - 60 - 70 - 80 - 100

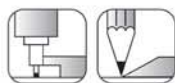
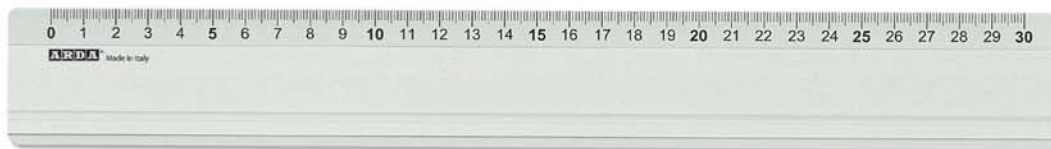

Gomma antiscivolo e tirachina
With no-sliding rubber and ink-edge
Avec patin antidérapant et bord anti-tache



LASERTEK
INCISIONE LASER

Art.	EAN13 art.	Descrizione / Description	INNER pcs	EAN13 inner	MASTER pcs
18230	8003438182302	cm. 30	3	8003438198303	30
18240	8003438182401	cm. 40	3	8003438198402	30
18250	8003438182500	cm. 50	3	8003438198501	30
18260	8003438182609	cm. 60	3	8003438198600	30
18270	8003438182708	cm. 70	1	8003438182708	3
18280	8003438182807	cm. 80	1	8003438182807	3
182100	8003438182104	cm. 100	1	8003438182104	3

L'incisione laser garantisce l'assoluta indelebilità dei numeri e dei millimetri
Laser engraving guarantees the absolute indelibility of numbers and millimeters
La gravure au laser garantit l'indélébilité absolue des nombres et des millimètres

Righe bordo acciaio

Rulers. Stainless steel edge
Règles. Bord en acier

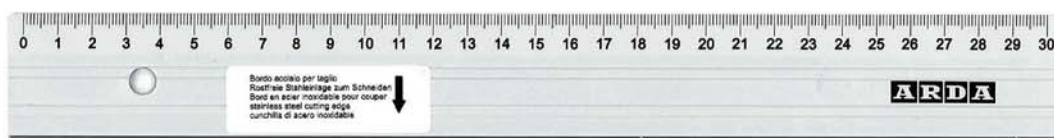
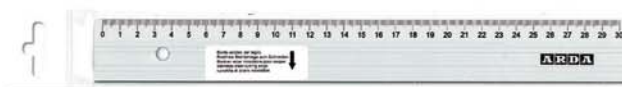

Ref. 18330 - 40 - 50 - 60 - 70 - 80 - 100 - 150

Gomma antiscivolo e tirachina
With no-sliding rubber and ink-edge
Avec patin antidérapant et bord anti-tache

Profilo di acciaio inossidabile integrato per resistere ai lavori di taglio
Integrated stainless steel profile to resist cutting jobs
Profil en acier inoxydable intégré pour résister aux travaux de coupe



Art.	EAN13 art.	Descrizione / Description	INNER pcs	EAN13 inner	MASTER pcs
18330	8003438183309	cm.30	1	8003438183309	10
18340	8003438183408	cm.40	1	8003438183408	10
18350	8003438183507	cm.50	1	8003438183507	10
18360	8003438183606	cm.60	1	8003438183606	10
18370	8003438183705	cm.70	1	8003438183705	10
18380	8003438183804	cm.80	1	8003438183804	5
183100	8003438183101	cm.100	1	8003438183101	5
183150	8003438183156	cm.150	1	8003438183156	5

Doppio e Triplo decimetro

Finger grip ruler 20-30cm
Double e triple décimètre



2 millimetrate. Impugnatura lunga.
2 graduations. Long grip.
2 graduations. Longue poignée.



Ref. 18420



Ref. 18430

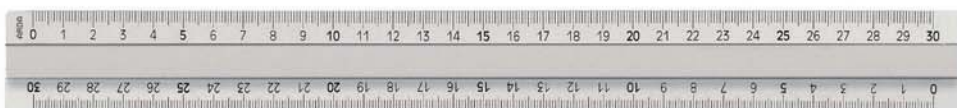

Art.	EAN13 art.	Descrizione / Description	INNER pcs	EAN13 inner	MASTER pcs
18420	8003438184207	cm. 20	3	8003438199201	30
18430	8003438184306	cm. 30	3	8003438189301	30

Righe T

T-squares
Règle à "T"

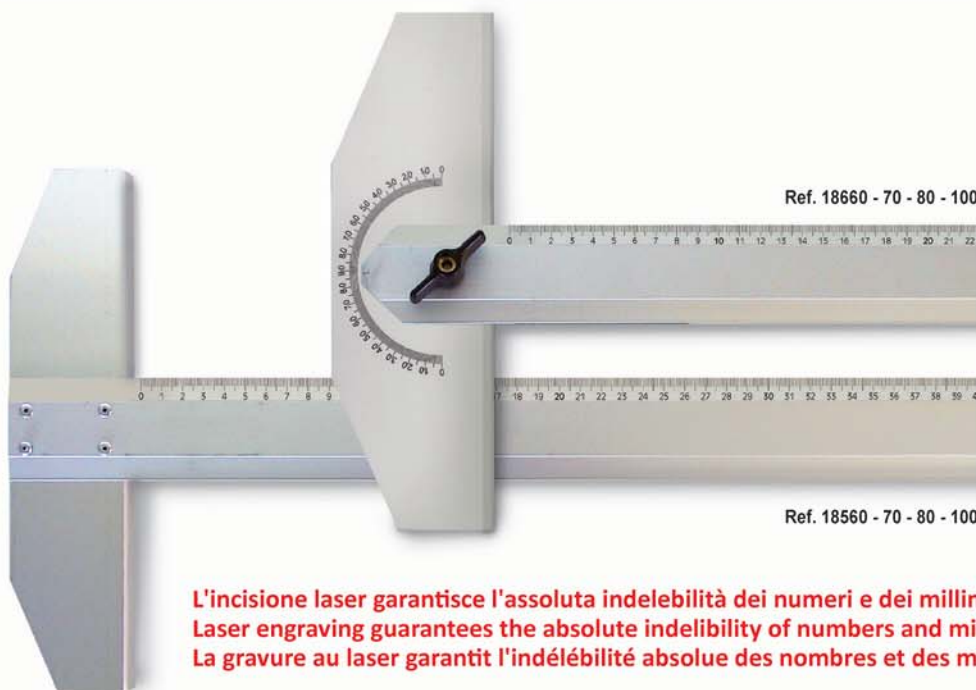

Ref. 18660 - 70 - 80 - 100

Ref. 18560 - 70 - 80 - 100

L'incisione laser garantisce l'assoluta indelebilità dei numeri e dei millimetri
Laser engraving guarantees the absolute indelibility of numbers and millimeters
La gravure au laser garantit l'indélébilité absolue des nombres et des millimètres

TESTA FISSA - Fixed head - Tête fixe

Art.	EAN13 art.	Descrizione / Description	INNER pcs	EAN13 inner	MASTER pcs
18560	8003438185600	cm.60	1	8003438185600	5
18570	8003438185709	cm.70	1	8003438185709	5
18580	8003438185808	cm.80	1	8003438185808	5
185100	8003438185105	cm.100	1	8003438185105	5

LASERTEK

**INCISIONE
LASER**

TESTA MOBILE - Mobile head - Tête mobile

Art.	EAN13 art.	Descrizione / Description	INNER pcs	EAN13 inner	MASTER pcs
18660	8003438186607	cm.60	1	8003438186607	5
18670	8003438186706	cm.70	1	8003438186706	5
18680	8003438186805	cm.80	1	8003438186805	5
186100	8003438186102	cm.100	1	8003438186102	5

Goniometro 360°

Protractor 360°
Rapporteur 360°



Millimetrati
With graduation - Avec graduation



Art.	EAN13 art.	Descrizione / Description	INNER pcs	EAN13 inner	MASTER pcs
18715	8003438187154	360° cm. 15	1	8003438187154	10

Espositore

Display
Presentoir

DISPLAY 26 pz / pcs

Art.	EAN13 art.	Descrizione / Description	INNER	MASTER
180ESP	8003438017215	3x Sq. 45° cm. 30 3x Sq. 60° cm. 30 1x Barattolo righelli 10 cm 1x Barattolo righelli 15 cm 6x Righe cm. 50 6x Doppio dec. cm. 20 6x Triplo dec. cm. 30	1	1

Disponibilità limitata alle campagne promozionali - Product availability limited to promotional campaigns - Disponibilité limitée aux campagnes promotionnelles

26
pcs

Ref. 180ESP
35,5 x 24 x 63 h. cm



Barattoli righelli

Ruler containers
Pots de règles

Bordo tirachina
Ink-edge - Bord anti-tache



15 pcs



Ref. 17910BAR
15 pz



Ref. 17915BAR
15 pz



Ref. 17920BAR
15 pz

cm 10 - cm 15 - cm 20



Art.	EAN13 art.	Descrizione / Description	INNER pz/pcs	EAN13 inner	MASTER pz/pcs
17910BAR	8003438007438	Bar. 15 pz - cm.10 (ean pz 8003438 015471)	1	8003438007438	12
17915BAR	8003438006981	Bar. 15 pz - cm.15 (ean pz 8003438 015457)	1	8003438006981	10
17920BAR	8003438023414	Bar. 15 pz - cm.20 (ean pz 8003438 023407)	1	8003438023414	10

Righelli

Rulers
Règles

Bordo tirachina
Ink-edge - Bord anti-tache



cm.10
Ref. 17910SS



cm.15
Ref. 17915SS



cm.20
Ref. 17920SS

Art.	EAN13 art.	Descrizione / Description	INNER pcs	EAN13 inner	MASTER pcs
17910SS	8003438019141	cm 10 - busta SS	10	8003438019202	10
17915SS	8003438007032	cm 15 - busta SS	10	8003438007230	10
17920SS	8003438007049	cm 20 - busta SS	10	8003438007063	10

Squadrette cm. 12

Small set square cm. 12
Petites équerres cm. 12

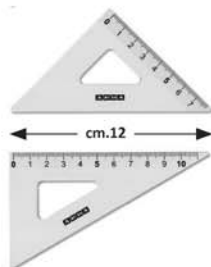

Ref. 18012
45° cm.12



Ref. 18112
60° cm.12



Ref. 80312
45° cm.12 + 60° cm.12

Art.	EAN13 art.	Descrizione / Description	INNER pcs	EAN13 inner	MASTER pcs
18012	8003438025685	45° cm.12	10	8003438025708	10
18112	8003438025692	60° cm.12	10	8003438025715	10
80312	8003438007414	45° + 60° cm.12	10	8003438007421	10



Minikit 3 pz.

Minikit 3 pz.
Minikit 3 pcs.

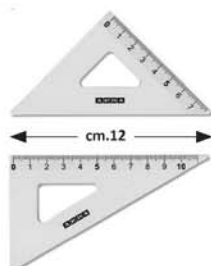

Ref. 1893
Miniset 3 pz/pcs :
45° 12 cm
+ 60° 12 cm
+ Riga 15 cm

Art.	EAN13 art.	Descrizione / Description	INNER pcs	EAN13 inner	MASTER pcs
1893	8003438022752	miniset alu 3 pz/pcs	10	8003438022769	10

Espositore

Display
Presentoir



cm.12

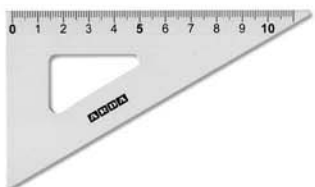

44
pcs

Ref. 181ESP

Ean singolo/per item/à l'unité



Art.	EAN13 art.	Descrizione / Description	INNER pcs	EAN13 inner	MASTER pcs
181ESP	8003438023308	Display 44 pz : - 24 pz cm.15 (ean pz 8003438 015457) - 10 pz 45° cm.12 (ean pz 8003438 023384) - 10 pz 60° cm.12 (ean pz 8003438023391)	1	8003438023308	1

MASCHERE, NORMOGRAFI

Lettering stencils, templates
Gabarits et normographe

Made in Italy
Italian quality & design

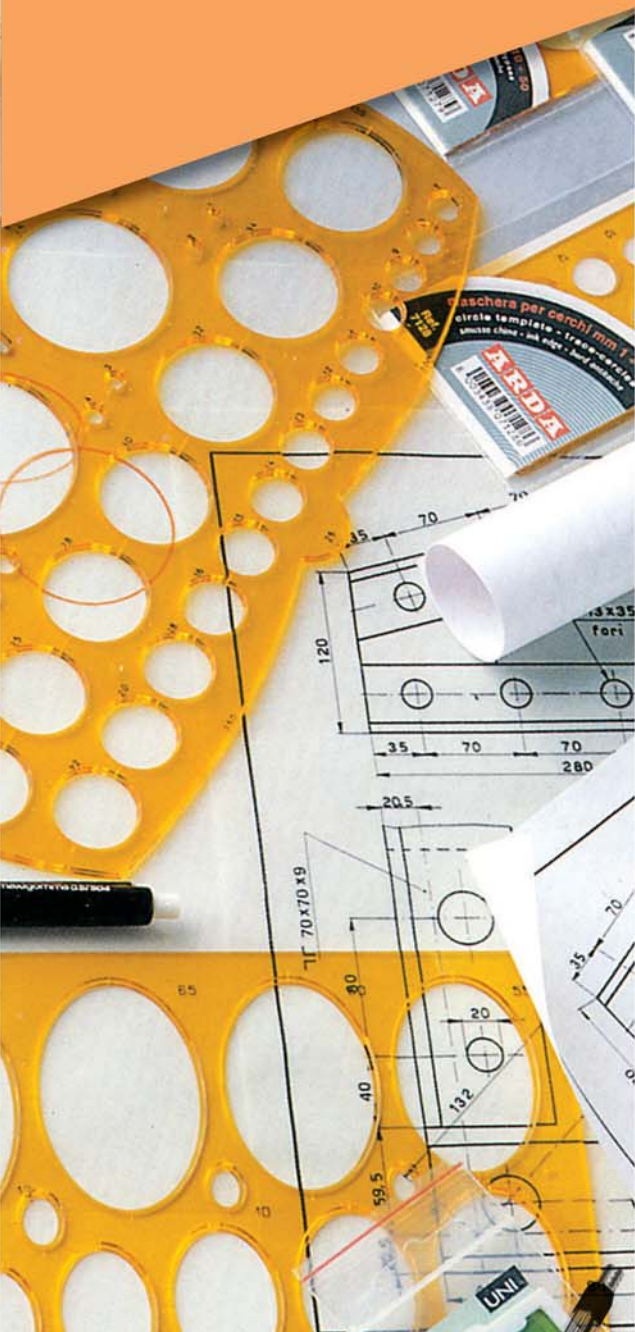

MASCHERE e NORMOGRAFI

Sono proposti i modelli di più ampio impiego e utilizzo. Quelli in colore arancio sono muniti di ribasso per disegno con china e quelli verdi sono senza ribasso per disegno a matita. I normografi sono adatti per scrivere con la matita o con la china e sono disponibili con caratteri norme UNI e ISO. Le righe normografiche e le normosfere si utilizzano con penna a sfera.

The range includes the most widely-used models. The orange articles have inking edges for ink drawings, while the green articles are not bevelled and are designed for pencil drawings. The lettering stencils are suitable for use with ink and pencil and are available with characters respecting ISO and UNI standards. The rulers with lettering stencils incorporated can also be used with ballpoint pens.

Dans cette gamme il y a une sélection des modèles les plus utilisés. Les modèles en couleur ocre ont le bord-antitache pour le dessin à chine tandis que ceux en couleur vert n'en sont pas fournis car ils sont utilisés pour le dessin à crayon. Les normographe sont utilisables soit avec la chine, soit avec le crayon. Ils sont disponibles selon les normes ISO et les normes UNI aussi. Les règles normographe et les trace-lettres peuvent être utilisés avec le stylo bille.

Maschere per cerchi

Circle template
Trace-cercles



Tirachina
ink-edge
bord anti-tache

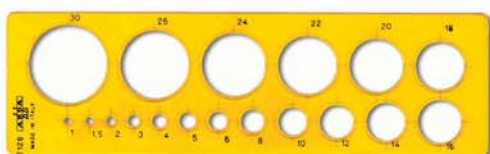

Ref. 7128

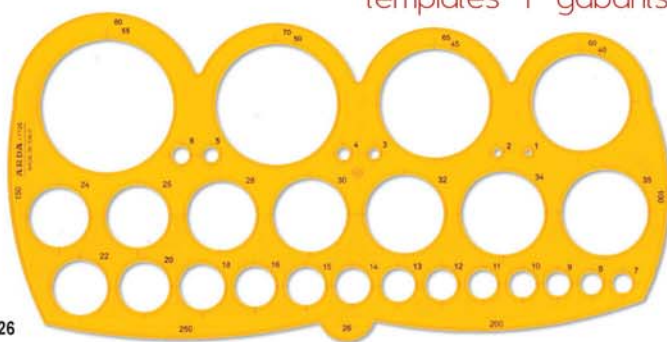

Ref. 7126

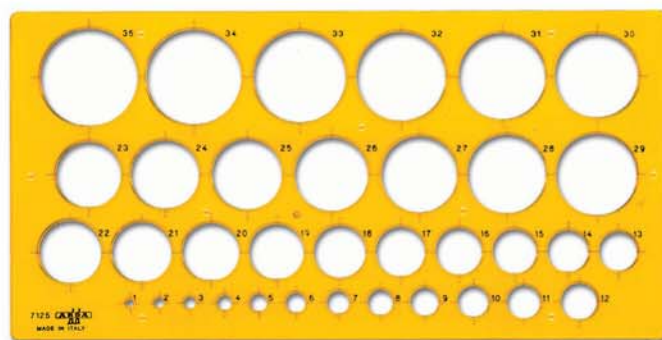

Ref. 7125

Art.	EAN13 art.	Descrizione / Description	Dimens. art.	INNER pcs	EAN13 inner	MASTER pcs
7125	8003438071255	mm. 1+35	247x124 mm	10	8003438171252	200
7126	8003438071262	mm. 1+55/80	278x141 mm	10	8003438171269	200
7128	8003438071286	mm 1+30	193x58 mm	10	8003438171283	500

Maschere per ellissi

Ellipses template
Gabarit ellipses



Tirachina
ink-edge
bord anti-tache



Ref. 7127

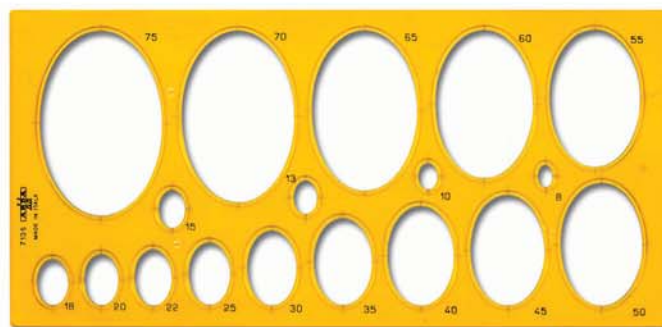

Ref. 7135

Art.	EAN13 art.	Descrizione / Description	Dimens.art.	INNER pcs	EAN13 inner	MASTER pcs
7127	8003438071279	mm. 10+50	196x63 mm	10	8003438171276	500
7135	8003438071354	mm. 8+75	270x130 mm	10	8003438171351	200

Maschere per quadri

Square template
Gabarit carrée



Tirachina
ink-edge
bord anti-tache

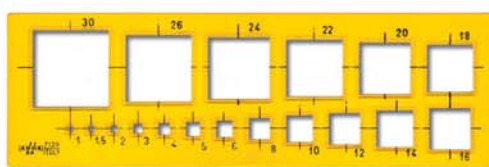

Ref. 7129

Art.	EAN13 art.	Descrizione / Description	Dimens. art.	INNER pcs	EAN13 inner	MASTER pcs
7129	8003438071293	mm. 1+30	197x63 mm	10	8003438171290	500

Maschere varie

Templates
Gabarits



Tirachina
ink-edge
bord anti-tache

Ref. 7130

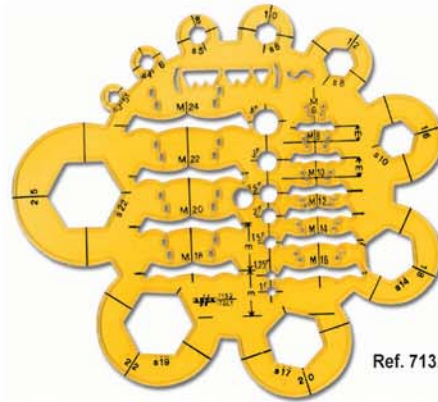
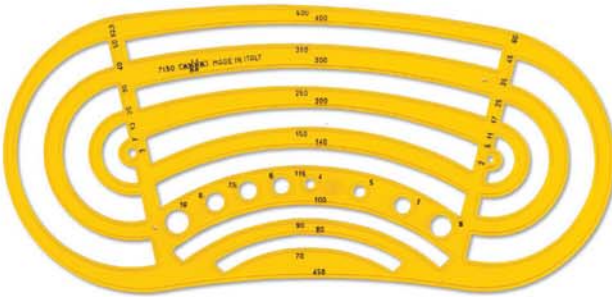

Ref. 7132

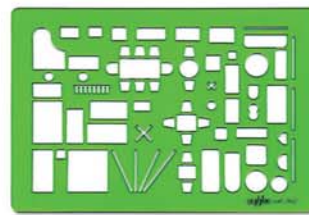

Ref. 7142

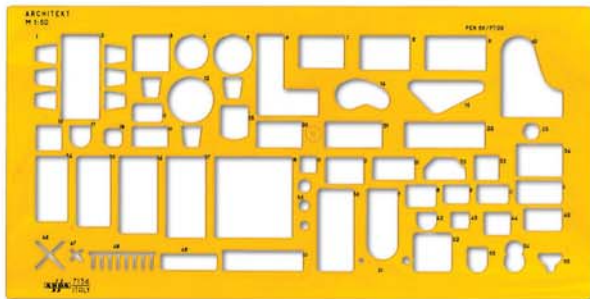

Ref. 7136

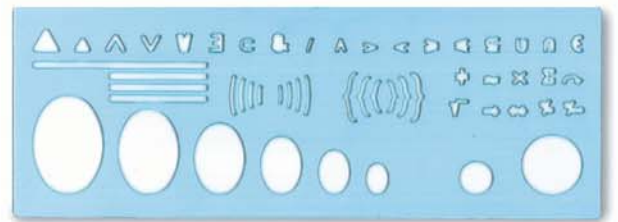

Ref. 7133

Art.	EAN13 art.	Descrizione / Description	INNER pcs	EAN13 inner	MASTER pcs
7130	8003438071309	Maschera per raccordi	10	8003438171306	10
7132	8003438071323	Maschera per dadi e bulloni piccola	10	8003438171320	10
7133	8003438071330	Ellissi e matematica moderna	10	8003438171337	10
7136	8003438071361	Arredamento scala 1:50	10	8003438171368	10
7142	8003438071422	Arredamento scala 1:100	10	8003438171429	10

Parabola

Parabel
Parable



Tirachina
ink-edge
bord anti-tache

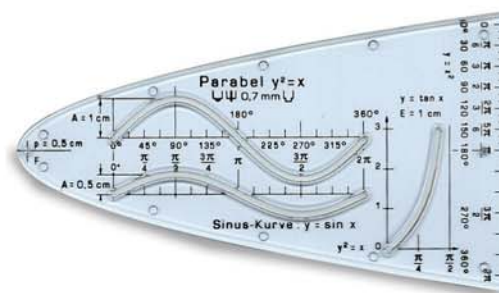

Ref. 7149

Art.	EAN13 art.	Descrizione / Description	INNER pcs	EAN13 inner	MASTER pcs
7149	8003438071491	Parabola	20	8003438171498	20

Maschere varie

Templates
Gabarits

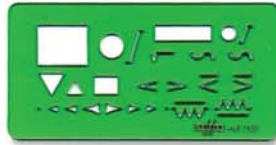

Ref. 7137



Ref. 7138

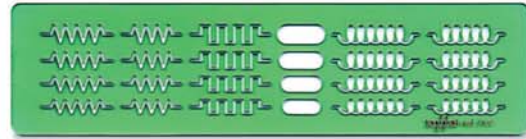

Ref. 7139

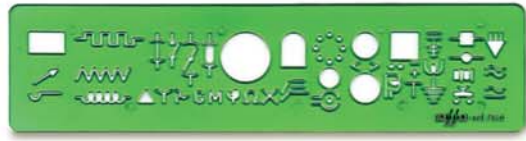

Ref. 7140



Ref. 7141

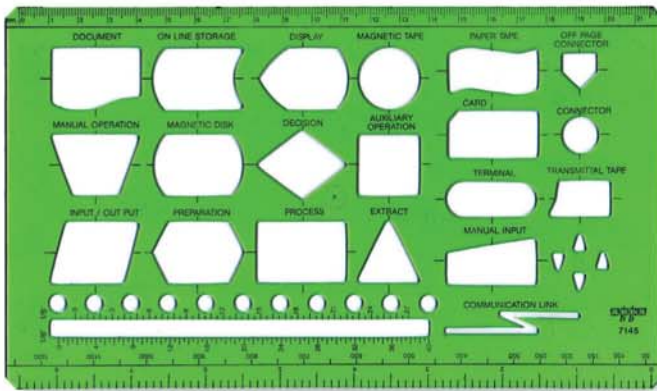

Ref. 7145

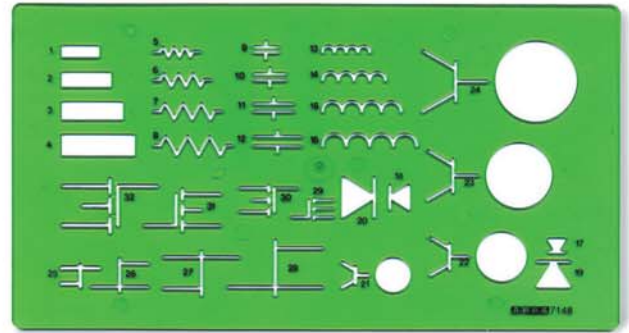

Ref. 7148

Art.	EAN13 art.	Descrizione / Description	INNER pcs	EAN13 inner	MASTER pcs
7137	8003438071378	Maschera per UNI VI	10	8003438171375	10
7138	8003438071385	Maschera per UNI II	10	8003438171382	10
7139	8003438071392	Maschera per resistenze	10	8003438171399	10
7140	8003438071408	Maschera per radiotecnica	10	8003438171405	10
7141	8003438071415	Maschera per elettrotecnici	10	8003438171412	10
7145	8003438071453	Maschera per informatica	10	8003438171450	10
7148	8003438071484	Maschera per elettronica	10	8003438171481	10

Normografi

Lettering guides
Normographs



Norme UNI - Ref. 30025 - 3 - 35 - 4 - 5 - 6 - 7 - 8 - 10 - 12 - 14



Norme ISO - Ref. 30235 - 5 - 7 - 10

NORME UNI

Art.	EAN13 art.	Descrizione / Description	INNER pcs	EAN13 inner	MASTER pcs
30025	8003438300256	h. caratteri mm.2,5	10	8003438310255	500
3003	8003438030030	h. caratteri mm.3	10	8003438031037	500
30035	8003438300355	h. caratteri mm.3,5	10	8003438310354	500
3004	8003438030047	h. caratteri mm.4	10	8003438031044	500
3005	8003438030054	h. caratteri mm.5	10	8003438031051	400
3006	8003438030061	h. caratteri mm.6	10	8003438031068	400
3007	8003438030078	h. caratteri mm.7	10	8003438031075	400
3008	8003438030085	h. caratteri mm.8	10	8003438031082	100
30010	8003438300102	h. caratteri mm.10	10	8003438310101	300
30012	8003438300126	h. caratteri mm.12	10	8003438310125	80
30014	8003438300140	h. caratteri mm.14	10	8003438311146	80

NORME ISO

Art.	EAN13 art.	Descrizione / Description	INNER pcs	EAN13 inner	MASTER pcs
30235	8003438302359	h. caratteri mm.3,5	10	8003438312358	280
3025	8003438303509	h. caratteri mm.5	10	8003438313508	280
3027	8003438303707	h. caratteri mm.7	10	8003438313706	280
30210	8003438303103	h. caratteri mm.10	10	8003438313102	120



Normosfere

Lettering stencils
trace-lettre pour crayon
à bille

PER PENNA
FOR PEN
POUR STYLO



ref. 5006



ref. 5008



ref. 5010



Art.	EAN13 art.	Descrizione / Description	INNER pcs	EAN13 inner	MASTER pcs
5006	8003438500601	6 mm	10	8003438500618	10
5008	8003438500809	8 mm	10	8003438500816	10
5010	8003438050014	10 mm	10	8003438150011	10

PORTAMINE

clutch pencil | porte-mine

PORTAMINE PER DISEGNO TECNICO

MECHANICAL PENCILS FOR TECHNICAL DRAWING

PORTE-MINES POUR DESSIN TECHNIQUE

La gamma comprende modelli che vanno dal 0.5 mm. fino a portamine per mine di 3 mm. I modelli tecnici hanno il fusto in ABS resistente agli urti e indeformabile e particolari in alluminio godronato e anodizzato. I modelli 0.5 hanno diverse caratteristiche in base alla fascia di prezzo.

The technical models have a barrel in shock-resistant undeformable ABS and details in knurled anodised aluminium. The models with 0.5 mm leads have different characteristics depending on the price.

Les modèles techniques ont un corps réalisé en ABS résistant aux chocs et donc indéformables. Les particuliers sont en aluminium anodisé. Les portemines avec mines de 0,5 mm ont des caractéristiques différentes par rapport aux prix.



TURNER 4019

2 mm

Made in Italy
Italian quality & design



Sezione esagonale
Hexagonal section
Section hexagonale

Best seller

Affilamine integrato
Sharpener integrated
Taille mine intégré

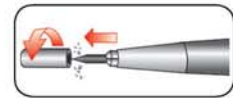

3 proposte di vendita:



Ref. 4019CART
Cartella / Folder / Dossier 12 pz/pcs



Ref. 4019COLESP
Display "Multicolour"
12 pz/pcs



Ref. 4019BL6
Blister

Mina a caduta libera - fermaglio, pulsante e puntale in metallo. Pinza a 3 morsetti. Affilamine integrato nel pulsante.

With free drop lead - pocket clip, push button and tip in metal. Leads holder with metal jaws clamp. Sharpener integrated in the push button.

Mine à libre chute - clip, bouton poussoir et pointe en métal. Pince à 3 sections en métal. Aiguise-mine intégré dans le bouton poussoir.

Art.	EAN13 art.	Descrizione / Description	INNER pcs	EAN13 inner	MASTER pcs
4019CART	- - -	Portamine 2 mm in cartella da 12 pz.	12	8003438010018	72
4019COLESP	8003438018045 (Ean display)	Display 12 pz / pcs "Multicolours"	1	8003438018045	10 display
4019BL6	8003438640192	Portamine 2 mm + tubetto 6 mine 2 mm in blister	20	8003438840196	20

DIAMANT 5024

max 3.0 mm UNIVERSALE

Made in Italy
Italian quality & design



Sezione ottagonale
Octagonal section
Section octogonale



Impugnatura antiscivolo in metallo
Non-slip metal grip zone
Zone de préhension en métal antidérapant

Affilamine integrato
Sharpener integrated
Taille mine intégré

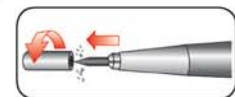

Ref. 5024CART
12 pz / pcs



Ref. 5024BL6

Mina a caduta libera. Fermaglio, pulsante e puntale in metallo. Impugnatura antiscivolo in metallo. Pinza a 4 morsetti. Affilamine integrato nel pulsante.

Free drop lead. Pocket clip, push button and tip in metal. Non-slip metal grip zone. Leads holder 4 metal jaws clamp. Sharpener integrated in the push button.

Mines à chute libre. Clip, bouton poussoir et pointe en métal. Zone de préhension en métal antidérapant. Pince à 4 sections en métal. Aiguise-mine intégré dans le bouton poussoir.

Art.	EAN13 art.	Descrizione / Description	INNER	EAN13 inner	MASTER
5024CART	8003438050243	Portamine fino a 3 mm in cartella da 12 pz.	12	8003438009975	72
5024BL6	8003438650245	Portamine fino a 3 mm + tubetto 6 mine 2 mm in blister	20	8003438850249	20

TURNER 4017

2.0 mm



Anello identificazione graduazione mina
Ring to identify the graduation of the lead
Bague pour identifier la graduation de la mine



Affilamine integrato
Sharpener integrated
Taille mine intégré



Sezione tonda
Round section
Section ronde



Ref. 4017ESP
Display 24 pcs



Ref. 4017BL6

Mina a caduta controllata - fermaglio e puntale in metallo. Affilamine integrato nel pulsante. Anello girevole per identificare la graduazione della mina all'interno. Finitura soft-touch del fusto.

Clutch pencil with spring-guided lead - clip and tip made of metal. Sharpener integrated in the push button. Rotating ring to identify the graduation of the lead inside. Soft-touch finish of the barrel.

Porte-mine avec avancement automatique - clip et pointe en métal. Taille mine intégré dans le bouton poussoir. Bague rotative pour identifier la graduation de la mine à l'intérieur. Soft-touch finition de la prise en main.

Art.	EAN13 art.	Descrizione / Description	INNER	EAN13 inner	MASTER
4017ESP	8003438020109 (ean display)	Display n.24 pz. (ean pcs 8003438 020079)	1	8003438020109	8 (display)
4017BL6	8003438020840	Portamine 2 mm + tubetto 6 mine 2 mm in blister	20	8003438020857	20

TURNER 5022

2.0 mm

Made in Italy
Italian quality & design

Ref. 5022CART
12 pz/ pcs



Impugnatura ergonomica
Ergonomic handle
Poignée ergonomique

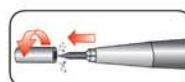

Affilamine integrato
Sharpener integrated
Taille mine intégré



Sezione esagonale
Hexagonal section
Section hexagonale

Mina ad avanzamento frenato. Fermaglio, pulsante e puntale in metallo. - Push mechanism for mechanical lead advance pocket clip, push button and tip in metal. - Mines avec avance automatique - clip, bouton poussoir et pointe en métal.

Art.	EAN13 art.	Descrizione / Description	INNER	EAN13 inner	MASTER
5022CART	8003438050229	Portamine 2 mm in cartella da 12 pz.	12	8003438010087	72

LANCASTER 903

0.5 mm

Impugnatura ergonomica
Ergonomic handle
Poignée ergonomique



Gommino incorporato
Eraser incorporated
Gomme incorporée



Ref. 903ESP
12 pz / pcs



Ref. 903BL12



Sezione triangolare
Triangular section
Section triangulaire

Mina a caduta controllata. Fermaglio, pulsante e puntale in metallo. Fusto a sezione triangolare per impugnatura ergonomica. Gommino incorporato.

Clutch pencil with spring-guided lead. Clip, push button and tip made of metal. Triangular barrel with ergonomic grip. Eraser incorporated.

Porte-mine avec avancement automatique. Clip et pointe en métal. Corps à section triangulaire pour prise en main ergonomique. Gomme incorporée.

Art.	EAN13 art.	Descrizione / Description	INNER	EAN13 inner	MASTER
903ESP	8003438020116 (ean display)	Display n.12 pz. (ean pcs 8003438 020086)	1	8003438020116	10 (display)
903BL12	8003438021786	Portamine 0,5 mm + tubetto 12 mine 0,5 mm in blister	20	8003438021809	20

LANCASTER 912

0.7 mm

Gomma incorporata
Eraser incorporated - Gomme incorporée



Impugnatura ergonomica in gomma soft, removibile
Ergonomic grip in soft-touch, no sliding rubber, removable
Prise en main ergonomique en gomme souple et anti-dérapant, amovible



Sezione tonda
Round section
Section ronde

Mina a caduta controllata. Impugnatura ergonomica in gomma soft antiscivolo. Gomma.

Clutch pencil with spring-guided lead.
Ergonomic grip in soft-touch, non sliding rubber. Eraser.

Porte-mine avec avancement automatique. Prise en main ergonomique en gomme souple et anti-dérapant. Gomme.



Ref. 912ESP
24 pz / pcs



Ref. 912BL12

Art.	EAN13 art.	Descrizione / Description	INNER	EAN13 inner	MASTER
912ESP	8003438020123 (ean display)	Display n.24 pz. (ean pcs 8003438 020093)	1	8003438020123	4 (display)
912BL12	8003438021793	Portamine 0,7 mm + tubetto 12 mine in blister	20	8003438021816	20

MINE Leads - Mines

2.0 mm B



Ref. 5030



Ref. 5030BL

n.6 mine graduazione B nere Ø 2 mm - lunghezza 90 mm
n. 6 leads in B grade, black Ø 2 mm - 90 mm. long.
no. 6 mines - dureté B, noir Ø 2 mm. - Longueur 90 mm.

MINE Leads - Mines

0.5 - 0.7 mm HB



0,5 mm - ref. 503105



0,7 mm - ref. 503107

2 mm

Art.	EAN13 art.	Descrizione / Description	INNER	EAN13 inner	MASTER
5030	8003438150301	tubetto 6 mine 2 mm in barattolo da 15 tubetti	15	8003438050304	180
5030BL	8003438503008	n.1 tubetto 6 mine 2 mm in busta	20	8003438703002	20

0,5 - 0,7 mm

503105	8003438020598	Tubetto 12 mine 0,5 mm HB	12	8003438020628	12
503107	8003438020604	Tubetto 12 mine 0,7 mm HB	12	8003438020635	12

AFFILAMINE A CAMPANA

**Rotary lead pointer
Taille-crayon roulant**

Temperamine a rotazione per mine con Ø 2 mm.
Consente due tipi di affilatura: una a punta rotonda, smussata per il disegno a mano libera e la scrittura, e una appuntita ad ago, ideale per il disegno tecnico e di precisione. Spugna per pulire la mina.

Rotary sharpener for mines Ø 2 mm.
It allows two types of sharpening: one with a round tip, suitable for freehand drawing and writing, and one pointed tip, suitable for technical and precision drawing. Sponge to clean the mine.

taille-crayon roulant pour mines Ø 2 mm.
Pour deux types d'affûtage: l'un avec pointe ronde biseauté pour dessiner et écrire, et une pointue, idéale pour les dessins techniques et précis.
Éponge pour nettoyer la mine.



Ref. TE809



Art.	EAN13 art.	Descrizione / Description	INNER pcs	EAN13 inner	MASTER pcs
TE809	8003438026217	Temperamine a campana	6	8003438026224	414

RASCHIETTO AFFILAMINE

**Sandpaper scraper for leads
Recloir pour aguiser les mines**

Per affilare le mine. 10 foglietti di ricambio (2 grammature) e spugna per pulire la mina.

To sharpen mine. 10 sheets for replacement (2 weights) and sponge to clean the mines.

Pour aguiser la mine. 10 feuilles de remplacement (2 poids) et une éponge pour nettoyer la mine.



Ref. 909



Art.	EAN13 art.	Descrizione / Description	INNER pcs	EAN13 inner	MASTER pcs
909	8003438014795	Raschietto affilamine	20	8003438014801	200

ARDA



GUARDA CHE RIGHE!

**Espositore 45 pz.
righelli cm.16**

Display 45 pcs. Ruler cm.16
Presentoir 45 pcs. Règle cm.16

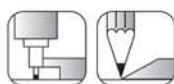

45
pcs

Ref. 28917DESPSK
Ean singolo/per item/à l'unité



**TEMPERAMATITE
COORDINATO**
Ref. TE800DSC
>> GO pg. 98



Art.	EAN13 art.	Descrizione / Description	INNER pcs	EAN13 inner	MASTER pcs
28917DESPSK	8003438020697	Display 45 righelli cm.16 (Ean pz 8003438020734)	1	8003438020697	1

Espositore 32 pz. righelli cm.16

Display 32 pcs. Ruler cm.16
Presentoir 32 pcs. Règle cm.16

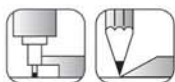

32 pcs
Ref. R17KCDESP
Ean singolo/per item/à l'unité



#KEEP COLOUR
diamant

EFFETTO METALLO
METAL FEELING
EFFET METAL

TEMPERAMATITE
COORDINATO
Ref. TE804KCDCS
>> GO pg. 96

Art.	EAN13 art.	Descrizione / Description	INNER pcs	EAN13 inner	MASTER pcs
R17KCDESP	8003438025784	Display 32 righelli cm.16 KEEP COLOUR DIAMANT (Ean pz 8003438024800)	1	8003438025784	1

Colori assortiti - Assorted colours - Couleurs assorties

Espositore 32 pz. righelli cm.16

Display 32 pcs. Ruler cm.16
Presentoir 32 pcs. Règle cm.16



32 pcs
Ref. R17FLESP
Ean singolo/per item/à l'unité



Puntatore compasso
Hole to point in compass
Pointeur pour compas

FLUO
colours



Art.	EAN13 art.	Descrizione / Description	INNER pcs	EAN13 inner	MASTER pcs
R17FLESP	8003438026187	Display 32 righelli cm.16 FLUO (Ean pz 8003438026194)	1	8003438026187	1

Colori assortiti - Assorted colours - Couleurs assorties

Barattolo righelli

16 cm

Pot containing rulers
Pot de règles

Righelli con tabelline, formule geometriche e tabelle conversioni.

Rulers with multiplication tables, geometric formulas and conversion tables.

Règles avec tables de multiplication, formules géométriques et tables de conversion.



Ean singolo/ per item à l'unité

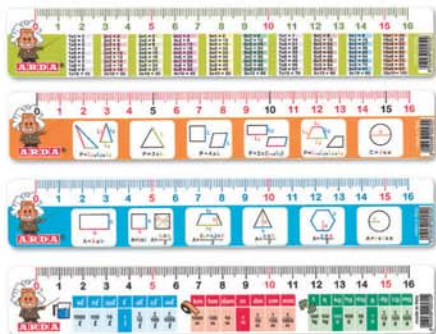

MATHEMATICS

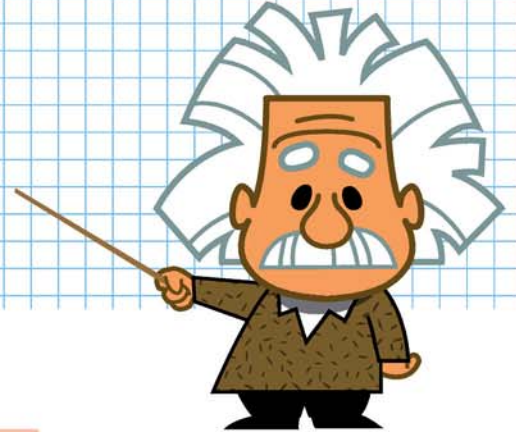

24 pcs

Ref. 28917MBAR

Art.	EAN13 art. 8003438...	INNER pz/pcs	EAN13 inner 8003438...	MASTER pz/pcs
28917MBAR	...025791	1	...025791	10

soggetti assortiti - assorted subjects - sujets assorties
Articolo singolo / Each articles / Article à l'unité : 8003438 025722

TEMPERAMATITE COORDINATO

LATTINA MATHEMATICS

Barattolo in metallo con temperamatite in plastica. Con tabelline e formule geometriche.
Metal container with plastic sharpener. With multiplication tables and geometric formulas.
Canette en métal avec taille-crayon en plastique. Avec tables de multiplication et formules géométriques.

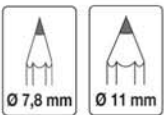

Ref. 825M



Ref. 825MSC
Display 12 pcs

Ean singolo/ per item à l'unité

Art.	EAN13 art.	Descrizione / Description	INNER pcs	EAN13 inner	MASTER pcs
825M	8003438027559	in blister	24	8003438027566	144
825MSC	8003438025746	in display 12 pz/pcs (ean display 8003438 025777)	24 (2 display)	8003438025753	144

**Espositore 45 pz.
righelli cm.16 FANTASY**

Display 45 pcs. Ruler cm.16
Presentoir 45 pcs. Règle cm.16

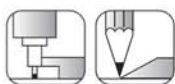

Ref. 28917DSS

45 pcs Ref. 28917DESP
Ean singolo/per item/và l'unità



Decori assortiti - Assorted decoration - Décors assortis

Art.	EAN13 art.	Descrizione / Description	INNER pcs	EAN13 inner	MASTER pcs
28917DESP	8003438014146	Display 45 righelli cm.16 FANTASY (Ean pz 8003438014191)	1	8003438014146	1
28917DSS	8003438014658	Riga cm.16 FANTASY in busta SS	20	8003438014665	800

**Espositore 25 pz.
righe cm.30 FANTASY**

Display 25 pcs. Ruler cm.30
Presentoir 25 pcs. Règle cm.30



Ref. 28930DSS



25 pcs Ref. 28930DESP
Ean singolo/per item/và l'unità



Personalizzabile
Customizable
Personnalisable

Art.	EAN13 art.	Descrizione / Description	INNER pcs	EAN13 inner	MASTER pcs
28930DESP	8003438015488	Display 25 pz righe cm.30 EMOTION (Ean pz 8003438 014894)	1	8003438015488	1
28930DSS	8003438014887	Riga cm.30 EMOTION in busta SS	20	8003438015327	360

Decori assortiti - Assorted decoration - Décors assortis

Flexi

Righe
Rulers
Règles



17 cm - Ref.118

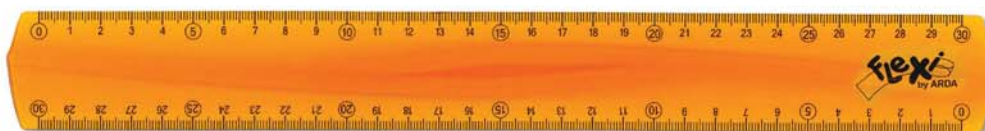

30 cm - Ref.119



Art.	EAN13 art.	Descrizione / Description	INNER pcs	EAN13 inner	MASTER pcs
118	8003438015358	cm. 17	20	8003438015372	320
119	8003438006929	cm. 30	20	8003438007117	320

Minikit 3 pz/pcs

R17 cm + 60° 15 cm + 180°10 cm

Ref.7063FLEX

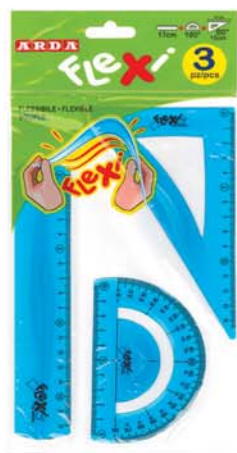

Art.	EAN13 art.	Descrizione / Description	INNER pcs	EAN13 inner	MASTER pcs
7063FLEX	8003438015341	Miniset 3 pz FLEXI	10	8003438015365	120

Espositore 50 pz.

Display 50 pcs
Presentoir 50 pcs

Art.	EAN13 art.	Descrizione / Description	INNER pcs	EAN13 inner	MASTER pcs
116ESP	8003438017994	Display 50 pz: 10x miniset + 20x Riga/Ruler/Règle 17 cm + 20x Riga/Ruler/Règle 30 cm	1	8003438017994	1